

Freyssinet Expansion Joints



D E S I G N , B U I L D , M A I N T A I N



FREYSSINET
SUSTAINABLE TECHNOLOGY

FREYSSINET INTEGRATED OFFER

For several decades, Freyssinet has been involved in developing structural accessories and has complete expertise in the related technology, installation and maintenance operations. Freyssinet now offers a range second to none for reliability and diversity along with exclusive associated services.

Freyssinet provides end-to-end support for the:

- design of expansion joints
- assistance for design offices
- manufacture of expansion joints
- installation by our specialist teams

Tens of thousands of metres of Freyssinet joints are installed every year in over 80 countries, offering guaranteed durability and features appropriate to all climates and traffic conditions.

Freyssinet expansion joints are certified and recognised worldwide by an accreditation of bodies.



WP 700 and WP 960 joints Lourés Bridge - Portugal

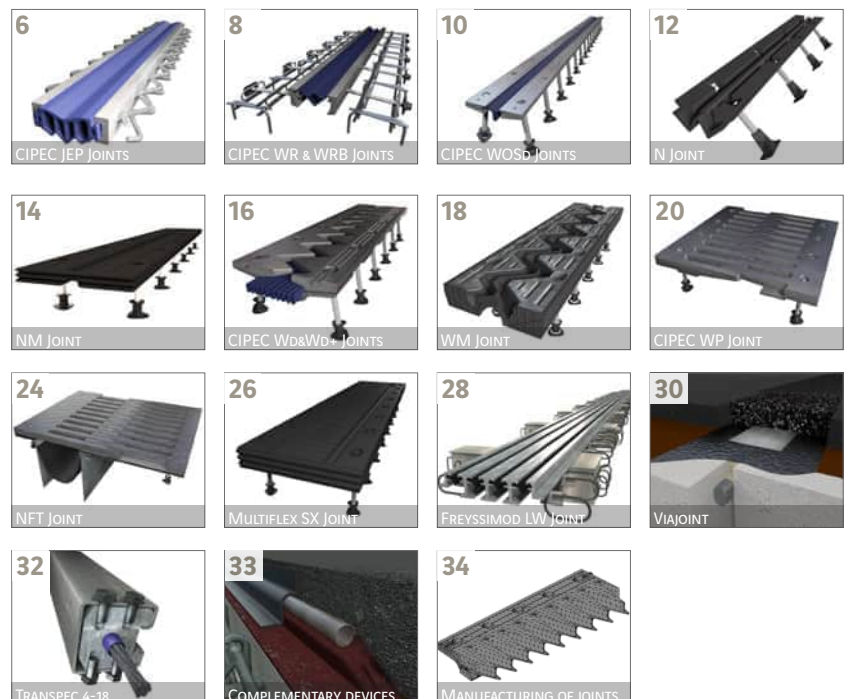

The Freyssinet Group

Freyssinet brings together **an unrivalled set of skills in the specialist civil engineering sector**. The company implements solutions with high added value in two major fields: construction and repairs.

Freyssinet is involved in numerous projects across five continents, making it the world leader in its specialist areas of:

- Prestressing
- Construction methods
- Cable-stayed structures
- Structural accessories
- Repairs
- Structural reinforcement and maintenance

Freyssinet is highly involved in sustainable development issues and has set up a number of initiatives to reduce the environmental impact of its projects and enhance its social responsibility policy.

Freyssinet is a subsidiary of the Soletanche Freyssinet Group, a world leader in the soils, structures and nuclear sectors.

Cover photo: Reconstruction of the bridge over the river Crni Timok - Gamzigrad, Serbia



FREYSSINET
SUSTAINABLE TECHNOLOGY

FEATURES OF FREYSSINET JOINTS

The expansion joint is without doubt the element under most strain in an engineering structure. Expert in managing the functionalities and stresses to which expansion joints are subjected, Freyssinet develops products designed to meet the site conditions and the climate and operating conditions of the structure.

Our solutions incorporate the following criteria:

Runoff water collection:
a decisive factor in design

Appropriate for all users:
cyclists, pedestrians, etc.

Permanent wheel contact with joint
for excellent driver comfort and low noise pollution

Account taken of structural movements
due to surface shrinkage, creep, temperature variations, deformation under load, effects of wind, earth movements, etc.

Adaptability to all types of structure
(concrete, steel, mixed)

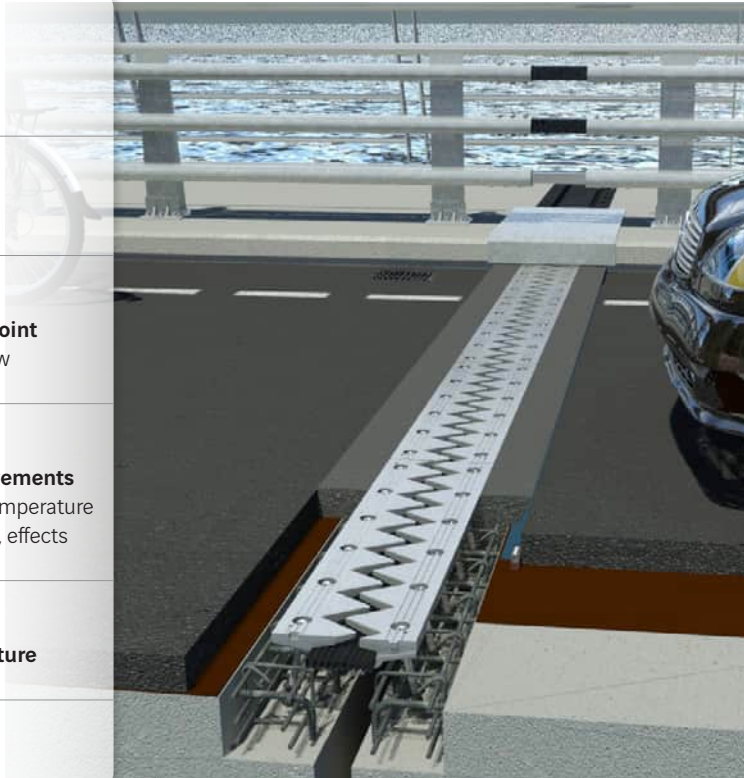

Barrier connection with Transpec 4-18

Footpath joints providing joint continuity
in non-traffic areas

Road surface continuity under different traffic loads (impact, fatigue, etc.)

Selected materials offering **exceptional resistance to aggressive elements** (oil, gravel, salt, sand, etc.)

Easy replacement in traffic flow conditions
through use of modular elements

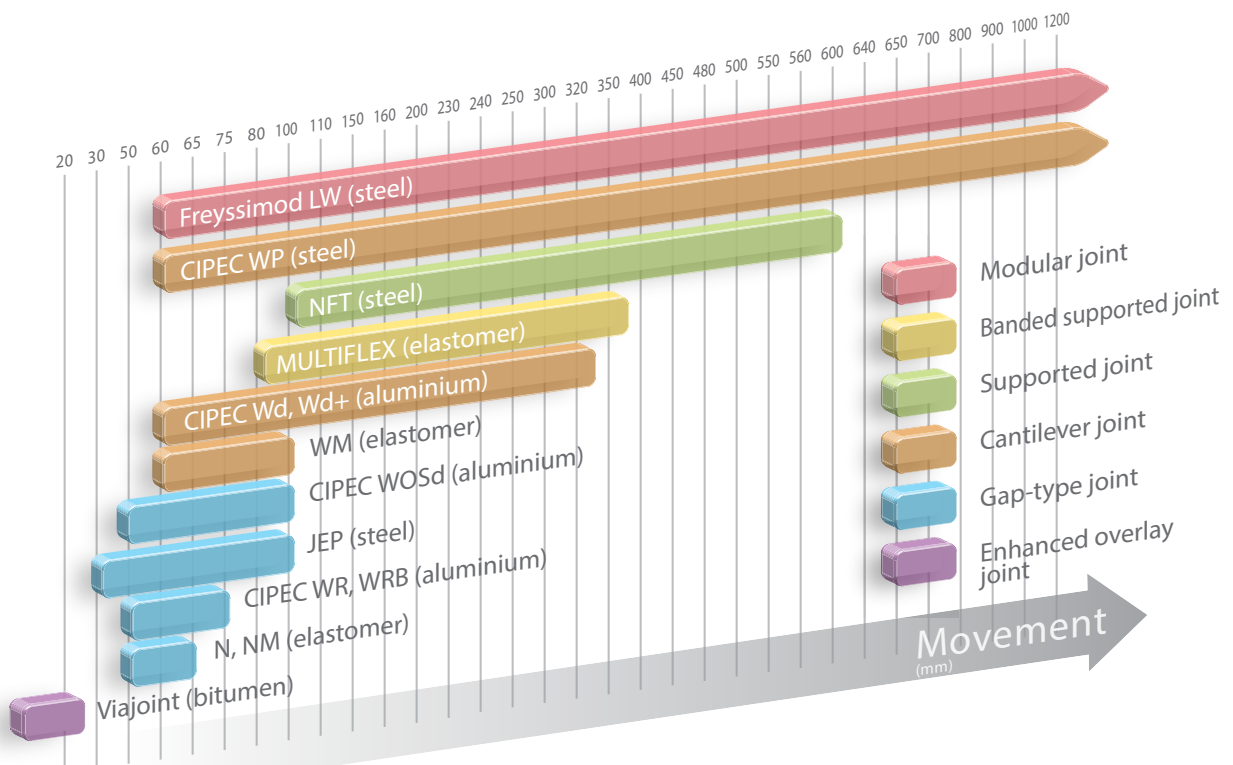

DESIGN OF JOINTS

Compliant with ETAG 32 recommendations, our expansion joints comprise 3 main elements:

- Aluminium alloy or drawn steel elements that ensure joint strength. Short modules facilitate maintenance and cleaning as well as installation in traffic flow conditions
- Anchoring systems that connect the joint to the main structure
- Elastomeric elements for sealing. A continuous elastomeric section is inserted along the entire length of the expansion joint between the metal elements. It prevents entry of foreign bodies and collects surface water runoff.

Freyssinet joints belong to the following expansion joint families:

- Enhanced overlay joint **Viajoint**
- Nosing joints **N**
NM
WR CIPEC
WRB CIPEC
JEP CIPEC
WOSd CIPEC
- Cantilever joints **WM**
Wd CIPEC
Wd+ CIPEC
WP
- Supported joint **NFT**
- Mat joint **Multiflex SX**
- Modular joint **Freyssimod LW**

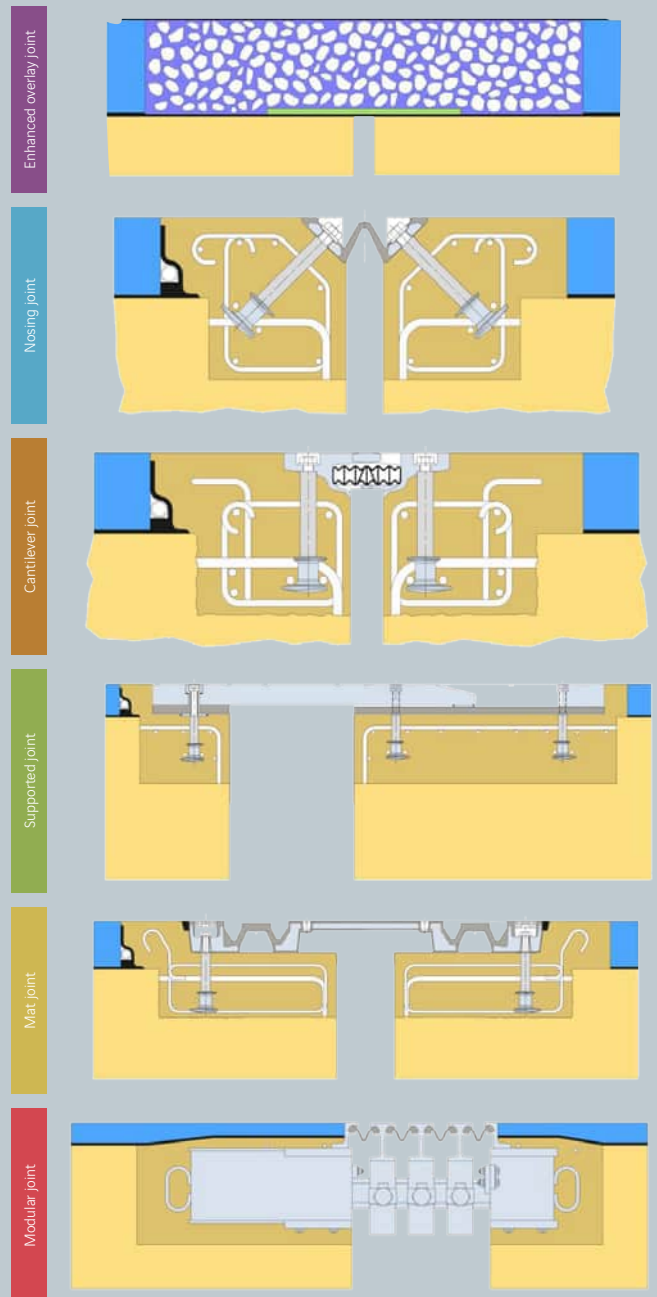

SELECTION CRITERIA

Joint type	Model	Heavy traffic	Traffic frequency	User comfort	Noise level	Sealing element	Transverse movement	Ease of maintenance	Durability
Enhanced overlay	Viajoint	★★★	★★★	★★★★★	★★★★★	★★★★★	★★	★★★★★	★★★
Nosing	N, NM	★★★	★★★	★★★	★★★	★★★★	★★★	★★★★	★★★
	WR, WRB	★★★★	★★★★	★★★	★★★	★★★	★★★★	★★★★	★★★★
	JEP	★★★★★	★★★★★	★★★	★★★	★★★★	★★★★	★★★	★★★★
	WOSd	★★★★	★★★★	★★★★	★★★	★★★★	★★★★	★★★★	★★★★
Cantilever	WM	★★★★★	★★★★★	★★★★★	★★★★	★★★	★★★	★★★★	★★★★
	Wd	★★★★★	★★★★★	★★★★★	★★★★★	★★★★	★★	★★★★	★★★★★
	WP	★★★★★	★★★★★	★★★★★	★★★★★	★★★★	★	★★★★★	★★★★★
Supported	NFT	★★★★★	★★★★★	★★★★★	★★★★★	★★★★	★	★★★	★★★★
Mat	Multiflex SX	★★★★	★★★	★★★★	★★★★	★★★	★★★	★★★★	★★★
Modular	Freyssimod LW	★★★★★	★★★★★	★★★	★★	★★★★★	★	★★★	★★★★★

INSTALLATION OF FREYSSINET JOINTS

Our experienced specialists regularly review all aspects of joint installation, an essential operation for guaranteed performance and durability:

- **Pre-adjustment of joints**

A joint's movement capacity can be set during installation to suit the structure's climate and operating conditions.

- **Installation principle**

There are various solutions for connecting the joint to the main structure: with rebate or within the thickness of the surface material.

- **Connection quality**

The tightening of the anchors to secure the joint is carefully controlled.

- **Drains and connection**

Installing drains increases joint durability by preventing seepage under the joint itself through its connection to the main structure's waterproofing system.

- **Modular assembly**

Assembly using special tools to ensure optimum road surface continuity, user comfort and reduced noise pollution.

- **Quality control**

Performed at every stage of the installation process.



DURABILITY

World-renowned for their durability and simple, robust design, Freyssinet expansion joints are perfectly suited to different usage conditions. The materials selected are designed to withstand continuous traffic growth and standard road maintenance techniques.

Our installation teams have the necessary expertise, qualifications and training for optimum joint installation. This unique experience allows us to provide the very best advice for our customers.



1. WD joint installation tool
2. Detail of anchorage
3. Installing a WP joint

CIPEC JEP JOINT

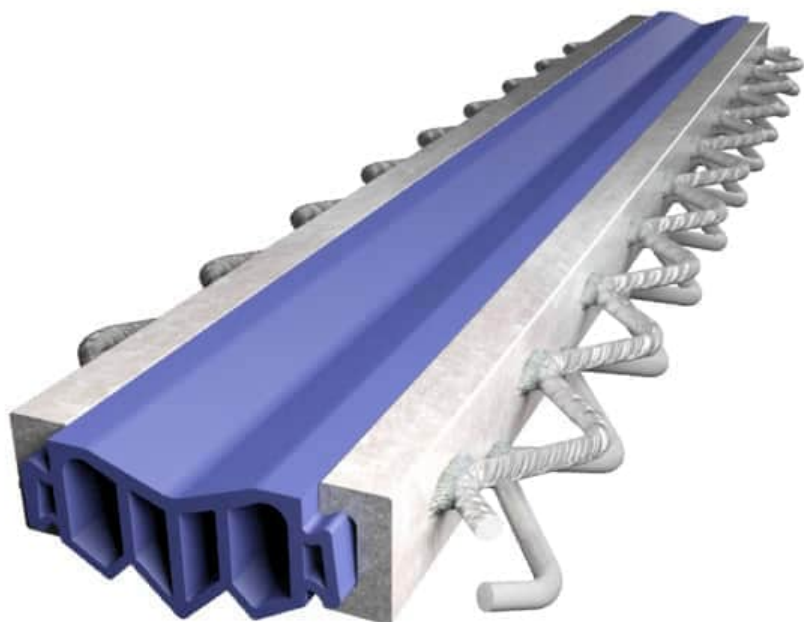

Design

Belonging to the nosing joint family, these joints comprise two extruded steel sections supplied in 3.50 metre lengths and placed facing each other.

These are fitted with two wavy steel anchoring sections embedded in a resin mortar beam bonded to the main structure.

A series of pairs of sections installed and butt-welded form the joint seam.



Specific features

- Installed within the thickness of surface material
- Quick to install with no recesses or drill holes in the main structure
- Ideal for solving specific problems such as the replacement of existing joints, work done lane by lane, renovation work requiring very short traffic interruptions and when speed of execution is all important
- Absence of saw-teeth means that JEP joints can accept large skew angles without any change to their intrinsic qualities

CIPEC JEP joint seam - Nice Airport - France

Movement range

The table opposite shows the movement capacity of JEP joints depending on the skew angle (α) of the main structure.

Type	Straight (100 gr)	80 gr	60 gr	40 gr
JEP3	30	31	37	51
JEP5	50	52	61	85
JEP8	80	84	98	136

Dimensions in mm

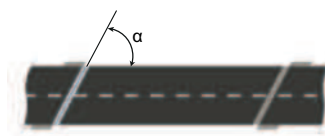

Technical data sheet

Type	B		G		E	H	I	J
	min.	max.	min.	max.	min.	min.		
JEP3	80	110	10	40	140	80	60	55
JEP5	75	125	10	60	140	80	75	59
JEP8	75	155	10	90	140	80	95	59

Dimensions in mm

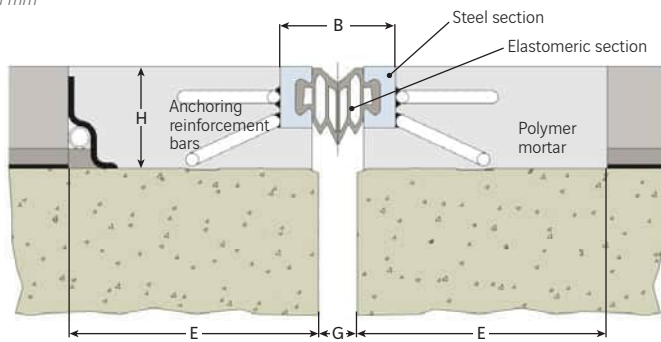

Elastomeric section models

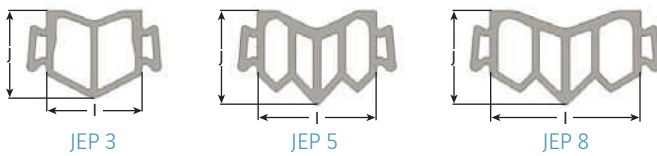

Accessories

To ensure general expansion joint watertightness and joint continuity on footpaths (or non-traffic areas), the following accessories are available:

- Footpath joints
- End section upstands and kerb cover plates
- Drains (see page 33)

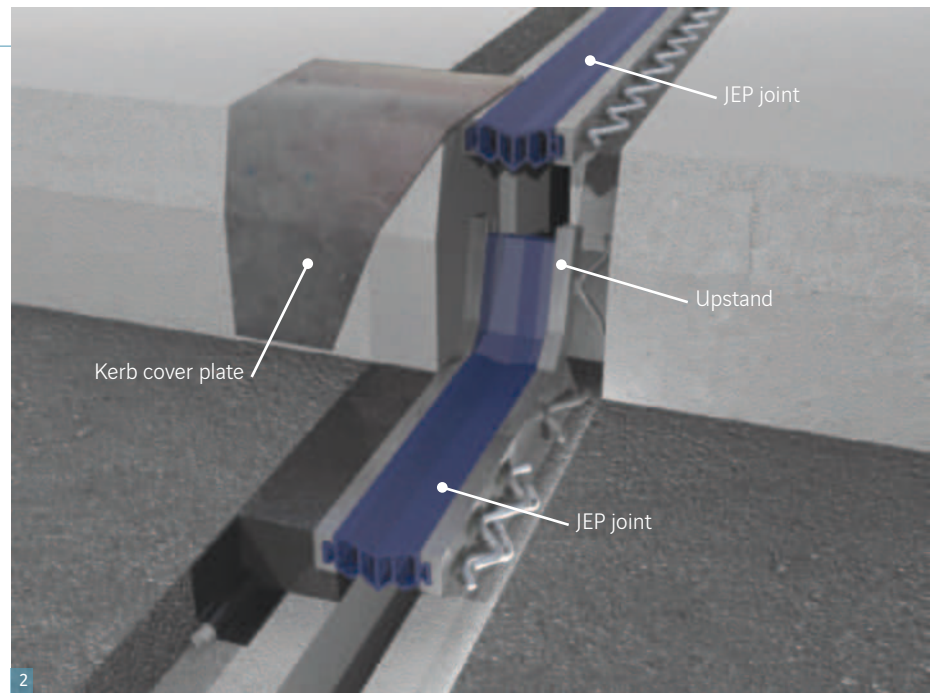

1. Anchoring a joint seam
2. 3D view of the upstand
3. JEP joint seam

CIPEC WR & WRB JOINTS



▲ WR with sleeves

WRB with anchor bars ►

Design

Belonging to the nosing joint family, these joints comprise two extruded aluminium alloy sections supplied in three metre lengths and laid facing each other.

The elements are anchored by means of a series of slightly inclined fasteners in reinforced microconcrete beams bonded to the main structure by seam reinforcement bars. These fasteners may comprise anchor rods with sleeves (WR model) or anchor bars with a load transfer plate (WRB model). A series of pairs of sections installed end-to-end forms the joint seam.



Specific features

- Installed within the thickness of surface material
- Quick to install with no recesses in the main structure
- Particularly economical
- Suitable for new and replacement works

1. Adjusting a WR joint
2. Concreting the flashing

Movement range

The table opposite shows the movement capacity of WR and WRB joints depending on the skew angle (α) of the main structure.

Type	Straight (100 gr)	80 gr	60 gr	40 gr
WR/WRB50	50	52	61	85
WR/WRB65	65	68	80	110
WR/WRB75	75	78	92	127

Dimensions in mm

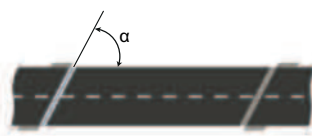

Technical data sheet

Type	B		G		E	H
	min.	max.	min.	max.	min.	min.
WR/WRB50	65	115	15	65	250/200	60/70
WR/WRB65	65	130	15	80	250/200	60/70
WR/WRB75	65	140	15	90	250/200	60/70

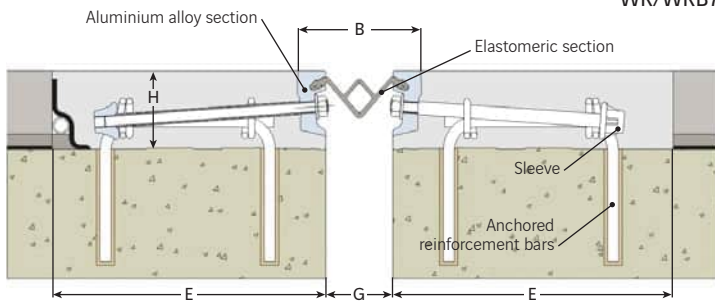

WR with sleeves

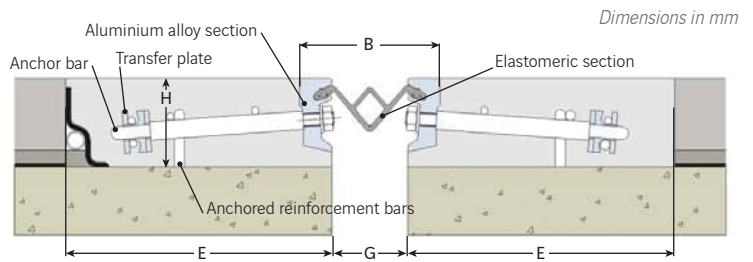

WRB with anchor bars

Dimensions in mm

Accessories

To ensure general expansion joint watertightness and joint continuity on footpaths (or non-traffic areas), the following accessories are available:

- Footpath joints
- End section upstands and kerb cover plates
- Drains (see page 33)



1

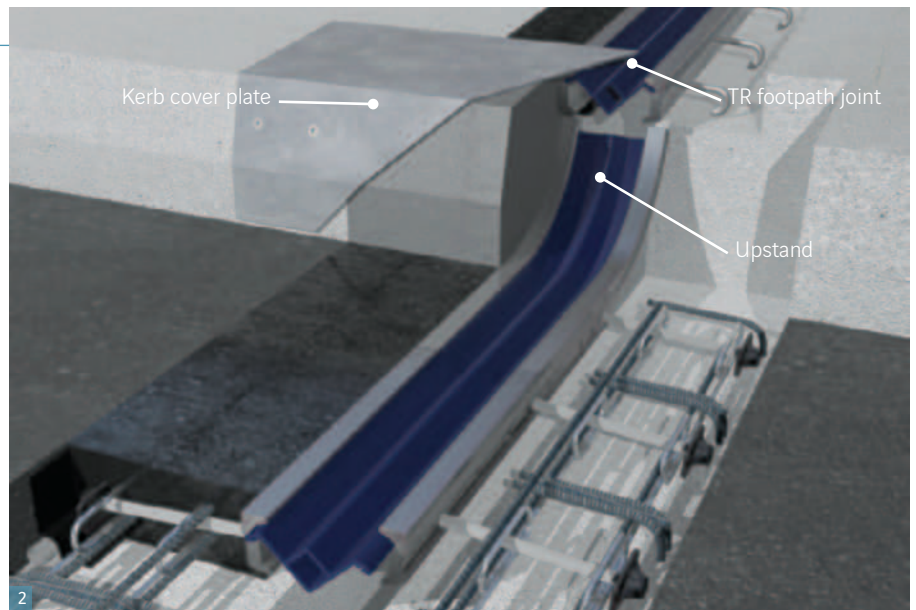

2

Type	Model	B		G		E	H
		min.	max.	min.	max.	min.	min.
WR/WRB50	TR50	65	115	15	65	150	100
WR/WRB65	TR65	65	130	15	80	150	100
WR/WRB75	TR75	65	140	15	90	150	100

Dimensions in mm

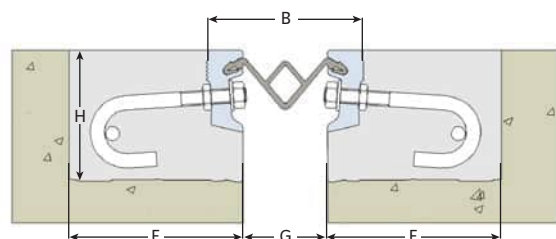

TR footpath joint

1. WR 50 joint Île Saint Louis Bridge - Paris
2. 3D view of the upstand

CIPEC WOSD JOINT



Design

Belonging to the nosing joint family, these joints comprise two extruded aluminium alloy sections supplied in three or six metre lengths and laid facing each other. A series of pairs of sections installed end-to-end form the joint seam. The metal elements are anchored to the main structure by fasteners.



Specific features

- Easily accessible anchor bolts and method of fastening the elastomeric section simplify the removal of WOSd joints if necessary (for example, during resurfacing work)
- The shape of the elastomeric section and its position slightly below the road surface mean that debris is simply removed by suction caused by passing vehicles
- Absence of saw-teeth means that WOSd joints can accept large skew angles without any change to their intrinsic qualities

1. Installing a WOSd joint
2. Adjusting a WOSd at the upstand
3. Tightening the anchors
4. Finished WOSd joint

Movement range

The table opposite shows the movement capacity of WOSd joints depending on the skew angle (α) of the main structure.

Type	Straight (100 gr)	80 gr	60 gr	40 gr
WOSd50	50	52	61	85
WOSd75	75	78	92	127
WOSd100	100	105	123	170

Dimensions in mm

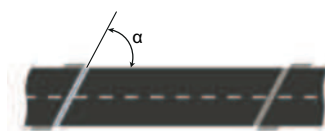

Technical data sheet

Type	B		G		E	H
	min.	max.	min.	max.	min.	min.
WOSd50	146	196	15	65	150	200
WOSd75	150	225	12	87	150	200
WOSd100	150	250	12	112	150	200

Dimensions in mm

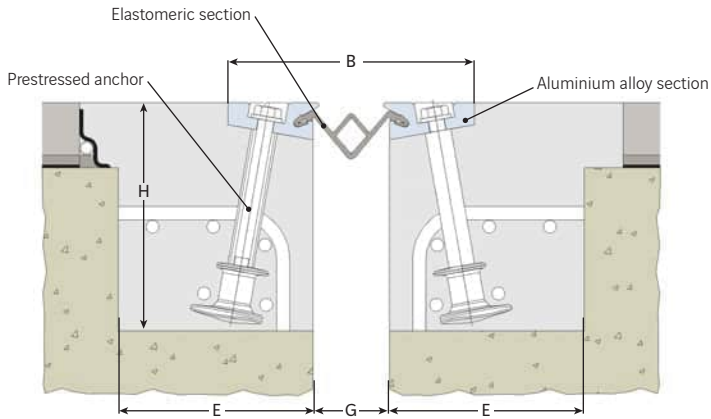

Elastomeric section models

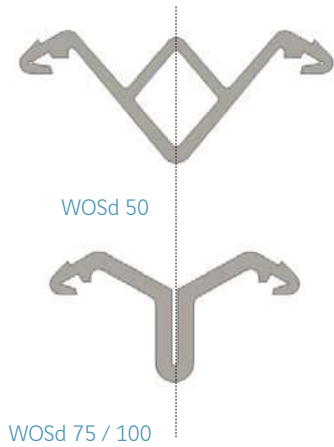

Accessories

To ensure general expansion joint watertightness and joint continuity on footpaths (or non-traffic areas), the following accessories are available:

- Footpath joints
- End section upstands and kerb cover plates
- Drains (see page 33)

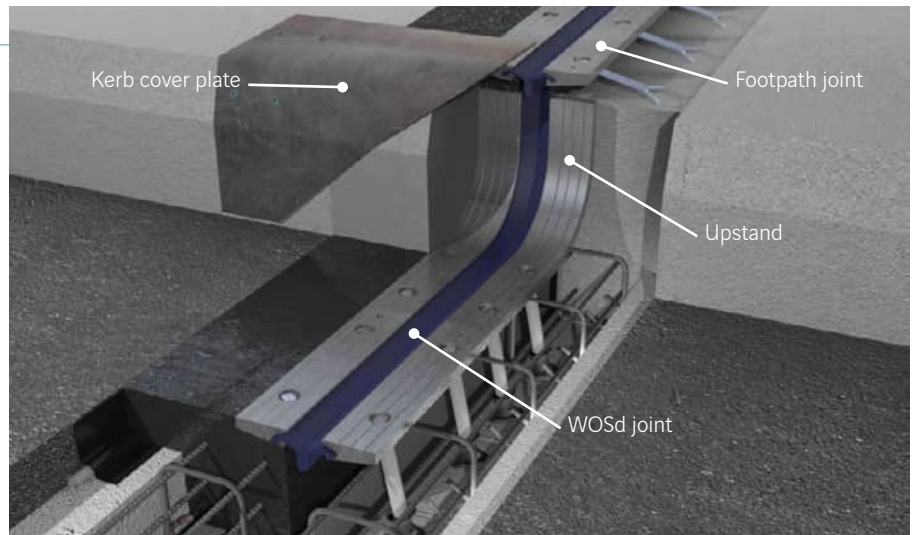

3D view of the upstand

Type	Model	B		G		E	H
		min.	max.	min.	max.	min.	min.
WOSd50	TO50	146	196	15	65	150	70
WOSd75	TO80	150	230	12	92	150	70
WOSd100	TO100	150	250	12	112	150	70

Dimensions in mm

TO footpath joint

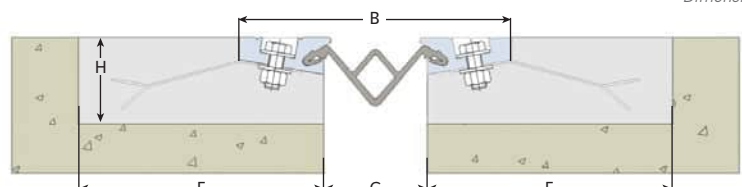

N JOINT



Design

The N joint is a one-piece nosing joint comprising 1 or 2 metre long moulded vulcanized elastomeric sections containing metal inserts shaped to ensure optimum service load transmission.



Specific features

- Watertightness ensured by total continuity of the elastomer on the elements and an overlap area where the elements meet
- The special shape of the N joint and contact by the elastomer absorb wheel impact and road surface irregularities, thereby providing an excellent level of user comfort
- Steel inserts entirely elastomer coated, fully protected against corrosion and chemical attack (oil, grease, hydrocarbons and de-icing salts)
- Especially simple to install.

N joint seam

Movement range

The N joint is designed with a single movement capacity of 65 mm. For skew angles under 70 gr, the movement capacity is reduced.

The table opposite shows the movement capacity of N joints depending on the skew angle (α) of the main structure.

Type	Straight (100 gr)	90 gr	80 gr	70 gr	60 gr	50 gr	40 gr
N65	65	65	68	52	40	33	29

Dimensions in mm

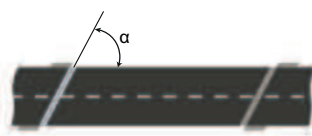

Technical data sheet

The N joint can be fastened with 2 types of anchor for installation either with rebate or directly within the thickness of the surface material.

Type	B		G		E	H
	min.	max.	min.	max.	min.	min.
N65 with/without rebate	120	185	20	85	170	200/70

Dimensions in mm

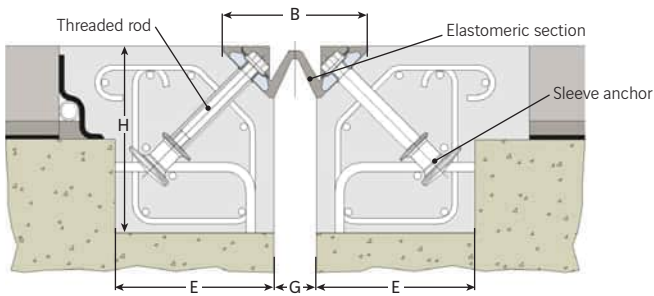

Installation with rebate

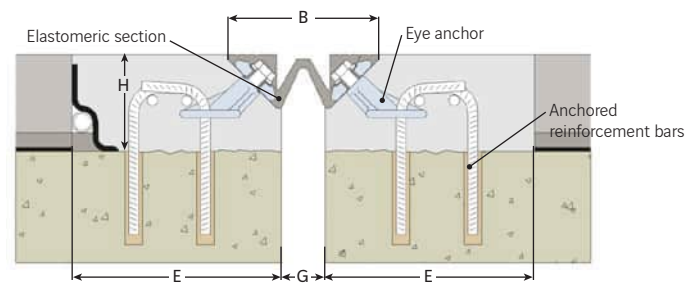

Installation without rebate



N joint with sleeve anchor

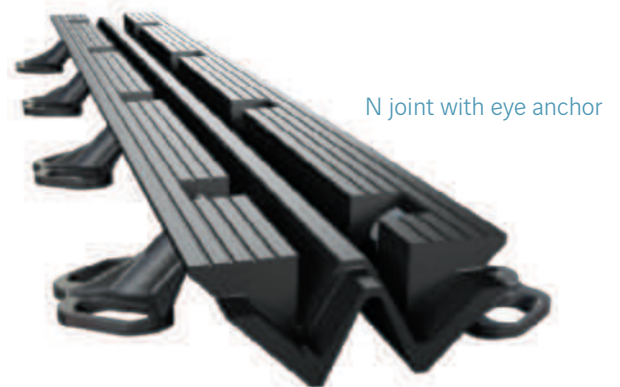

N joint with eye anchor

Accessories

To ensure general expansion joint watertightness and joint continuity on footpaths (or non-traffic areas), the following accessories are available:

- Footpath joints
- End section upstands
- Drains (see page 33)

Type	B		G		E	H
	min.	max.	min.	max.	min.	min.
N65	120	185	20	85	170	150

Dimensions in mm

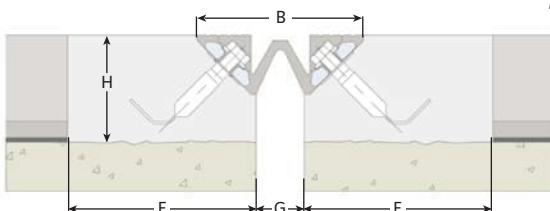

N footpath joint

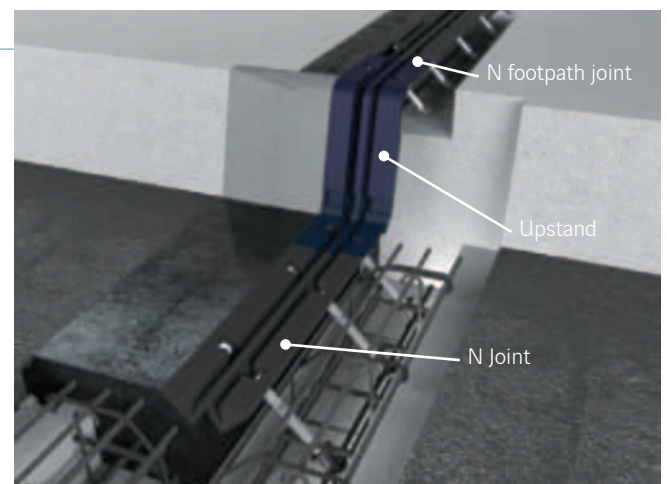

3D view of the upstand

NM JOINT



Design

The NM joint is a one-piece nosing joint. It comprises 2-metre moulded elastomeric elements containing steel bands. It is fastened to the main structure by M12 bolts sealed with resin or anchored by means of sleeves. They are available in galvanized or stainless steel.



Specific features

- The one-piece design of the joint, male/female join between elements and water recovery membrane ensure excellent watertightness
- Entirely coated steel elements and a galvanized or stainless steel fastening system provide excellent corrosion resistance
- The NM joint is very simple to install or replace on both new and existing structures

NM joint seam

Movement range

The NM joint is designed with a single movement capacity of 50 mm.

The table opposite shows the movement capacity of NM joints depending on the skew angle (α) of the main structure.

Type	Straight (100 gr)	90 gr	80 gr	70 gr	60 gr	50 gr	40 gr
NM50	50	50	52	40	30	25	22

Dimensions in mm

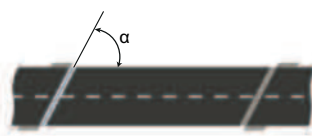

Technical data sheet

Type	B		G		E	H	Dimensions in mm
	min.	max.	min.	max.	min.	min.	
NM50	265	315	20	70	200	175	

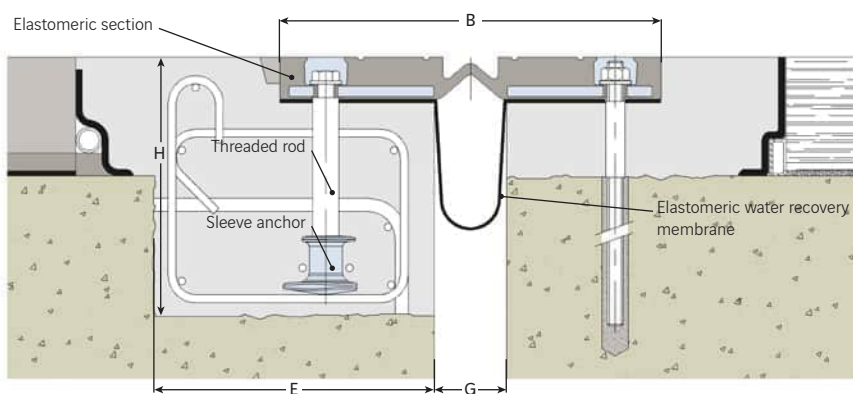

Anchoring using sleeves

Anchoring using sealed bolts

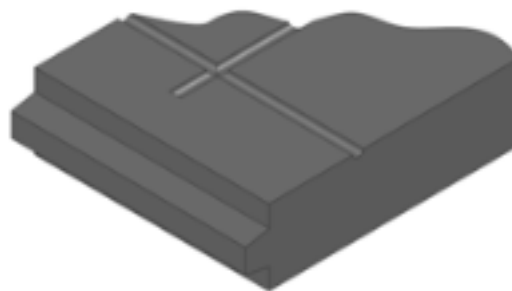
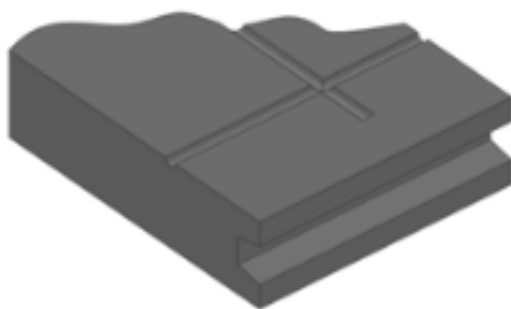

Joint between two elements

Accessories

To ensure general expansion joint watertightness and joint continuity on footpaths (or non-traffic areas), the following accessories are available:

- Footpath joints (all types used for other expansion joint types are suitable for this system)
- Drains (see page 33)

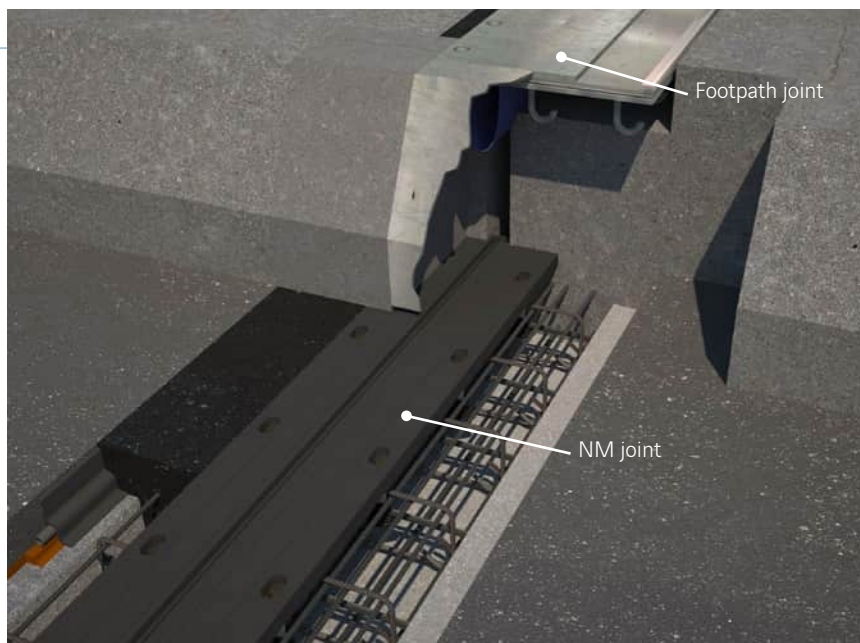

CIPEC Wd & Wd+ JOINTS



Design

Belonging to the cantilever saw-tooth family, this joint comprises a pair of individual cast aluminium alloy sections with triangular saw-teeth supplied in one metre lengths and laid facing each other. A series of pairs of elements installed end-to-end forms the joint seam.

The metal elements are anchored to the main structure by fasteners.

The bottom surface of the joint in contact with the concrete may be coated with epoxy paint (model Wd+) for main structures subject to high humidity and de-icing salts.



Specific features

- Exceptionally robust due to the use of tension control bolts to connect the metal elements to the main structure and the choice of materials. They are designed for intensive heavy traffic
- The triangular saw-teeth of the metal elements enable operation with no gap and so ensure perfect road surface continuity and significantly reduced noise over the joint
- Easily accessible anchor bolts and short elements make it easy to maintain and remove the joint with traffic interruption only necessary on the lane in question
- Wd and Wd+ joints accept skew angles up to 30 gr without any change to their intrinsic qualities

1. Installed Wd joint
2. Minnesund Bridge E10 - Norway

Movement range

The table opposite shows the movement capacity of Wd and Wd+ joints depending on the skew angle (α) of the main structure.

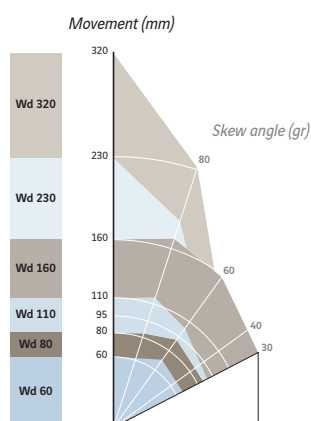

Type	Straight (100 gr)	80 gr	60 gr	40 gr	30gr
Wd/Wd+60	60	63	71	68	69
Wd/Wd+80	80	84	91	86	87
Wd/Wd+110	110	115	104	94	93
Wd/Wd+160	160	168	158	143	142
Wd/Wd+230	230	189	129	107	102
Wd/Wd+320	320	232	153	124	117

Dimensions in mm

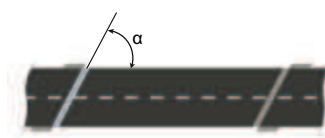

Technical data sheet

Type	B		G		E	H
	min.	max.	min.	max.	min.	min.
Wd/Wd+60	185	245	20	80	200	200
Wd/Wd+80	220	300	30	110	200	200
Wd/Wd+110	300	410	40	150	250	250
Wd/Wd+160	400	560	50	210	300	280
Wd/Wd+230	440	670	70	300	350	280
Wd/Wd+320	450	770	70	390	350	300

Dimensions in mm

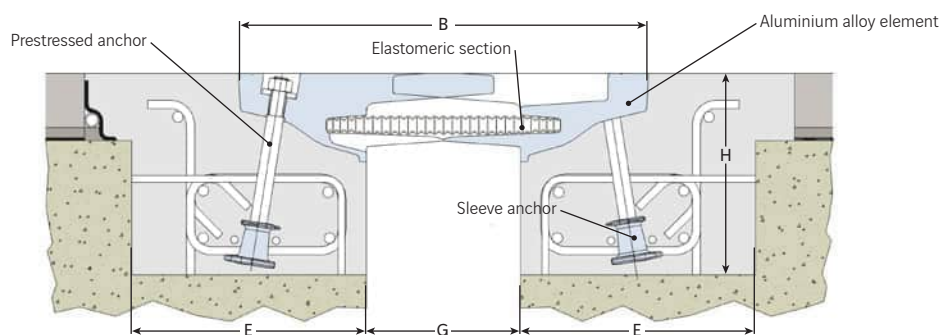

Accessories

To ensure general expansion joint watertightness and joint continuity on footpaths (or non-traffic areas), the following accessories are available:

- Footpath joints
- End section upstands and kerb cover plates
- Drains (see page 33)

Type	Model	B		G		E	F	H
		min.	max.	min.	max.	min.	min.	min.
Wd/Wd+60	TO80	150	230	12	92	150	-	70
Wd/Wd+80	TO80	150	230	12	92	150	-	70
Wd/Wd+110	PL110	220	330	20	130	150	300	150
Wd/Wd+160	PL160	280	440	30	190	150	350	150
Wd/Wd+230	PL230	360	590	40	270	150	420	150
Wd/Wd+320	PL350	490	840	50	400	150	540	150

Dimensions in mm

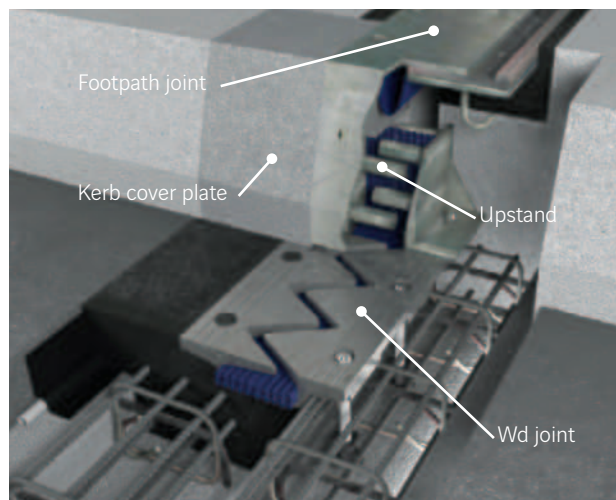

3D view of the upstand

TO footpath joint

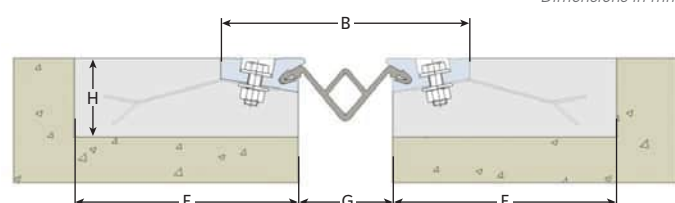

PL footpath joint

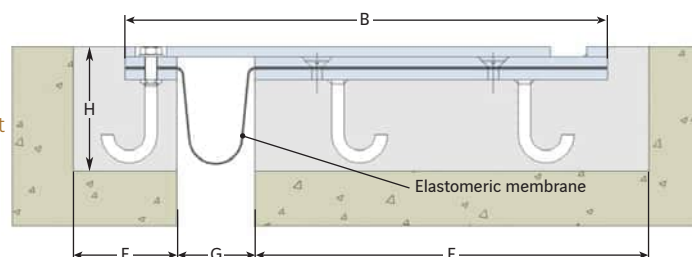

WM JOINT

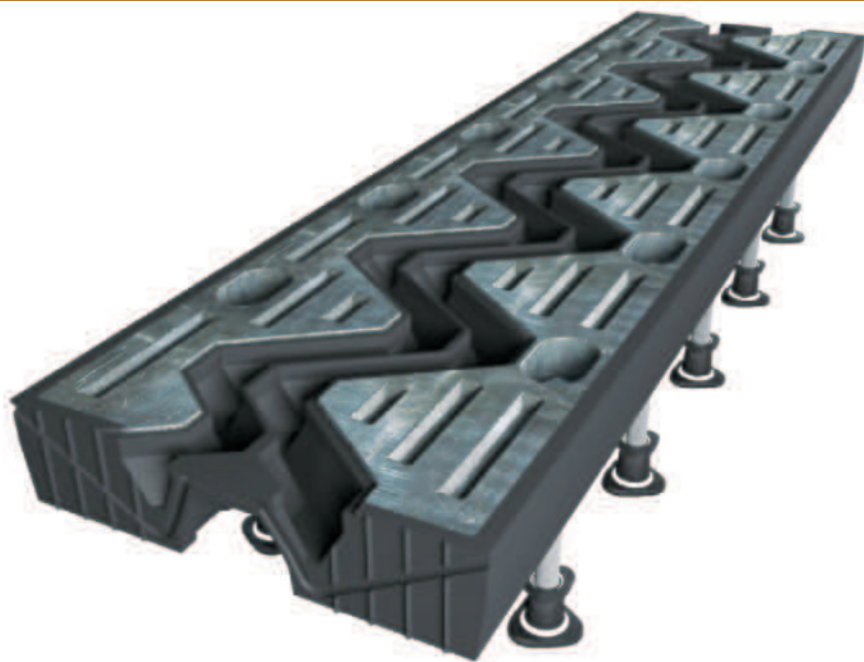

Design

The WM joint is a one-piece cantilever saw-tooth joint comprising metal elements designed to accommodate moving loads at the gap. The inserts are elastomer coated on surfaces not subject to abrasion to protect against corrosion. The traffic surface is made from corrosion-resistant metal. The waterproof membrane, although very close to the road surface to enable removal of debris, does not enter into direct contact with vehicle tyres.



Specific features

- Greatly improved durability through use of low corrosion materials (cast iron) protected by an elastomeric coating
- The bellows are bonded for watertightness on the metal elements, enabling runoff water to be channelled directly to the drainage system of the main structure
- Vertical fasteners comprising a sleeve embedded in the concrete and a prestressed bolt allow for easy replacement of elements if necessary
- New generation joint ideal as a replacement for the old M joint.

Partial replacement of an M joint by a WM joint

Movement range

Movement capacity depending on skew angle (α) of the main structure.

Type	Straight (100 gr)	90 gr	80 gr	70 gr	60 gr	50 gr	40 gr
WM80	80	80	84	88	68	56	49
WM100	100	101	105	88	68	56	49

Dimensions in mm

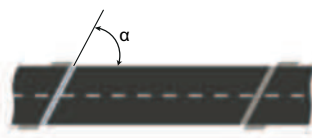

The transverse movement capacity of joints WM80 and WM100 is +/-20 mm.

Technical data sheet

Type	B		G		E	H
	min.	max.	min.	max.	min.	min.
WM80	165	245	10	90	170	210
WM100	225	325	15	115	200	210

Dimensions in mm

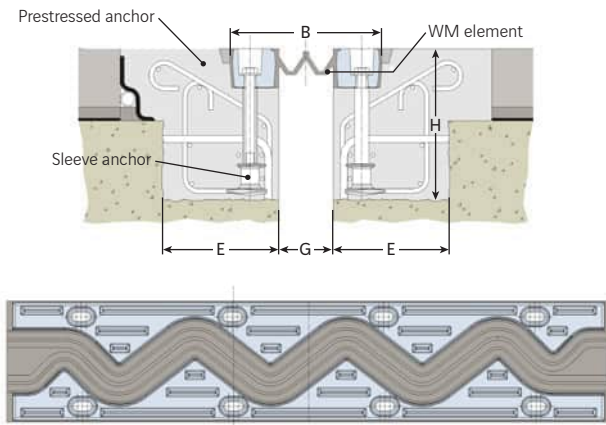

WM 80

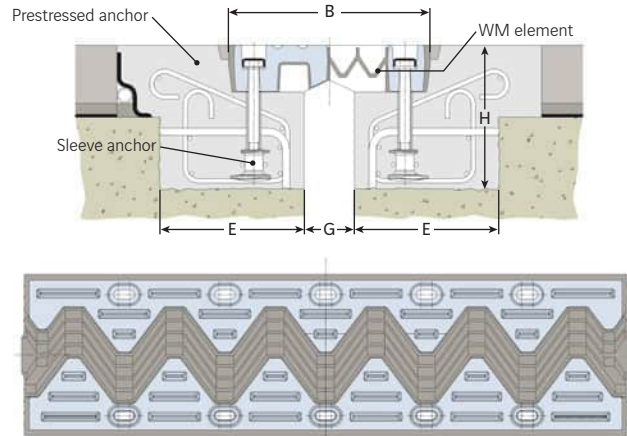

WM 100

Accessories

To ensure general expansion joint watertightness and joint continuity on footpaths (or non-traffic areas), the following accessories are available:

- Footpath joints
- End section upstands
- Drains (see page 33)

3D view of the TM footpath joint

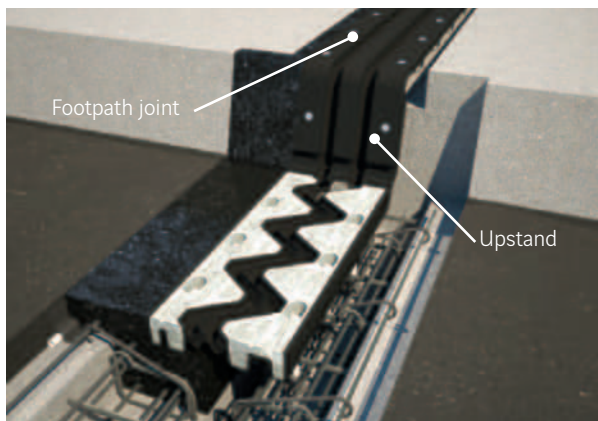

Type	Model	B		G		E	H
		min.	max.	min.	max.	min.	min.
WM80	M80	110	190	10	90	175	100
WM100	M100	155	255	15	115	175	100

Dimensions in mm

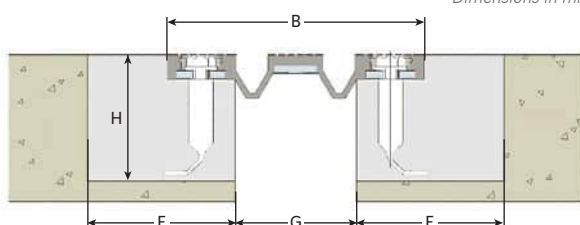

3D view of the TO footpath joint

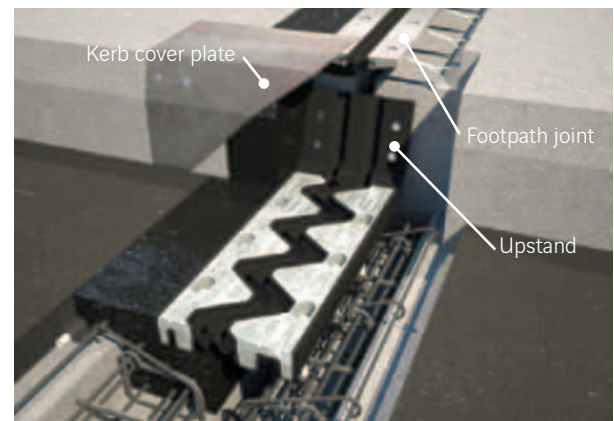

Type	Model	B		G		E	H
		min.	max.	min.	max.	min.	min.
WM80	TO80	150	230	12	92	150	70
WM100	TO100	150	250	12	112	150	70

Dimensions in mm

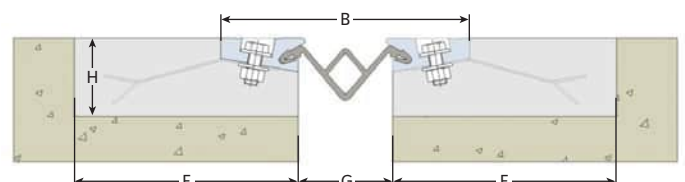

CIPEC WP JOINT



Design

Belonging to the cantilever comb family, this joint comprises a pair of individual elements (combs) with parallel saw-teeth supplied in one metre lengths and laid facing each other.

The combs are either flame cut from a rolled steel plate or aluminium alloy castings.

A series of pairs of elements installed end-to-end forms the joint seam. The metal elements are anchored to the main structure by tension control fasteners.



Specific features

- WP joints are manufactured to order and can be adapted to the directional movement of the main structure, straight (fig.1) or skew (fig.2)
- WP joints are exceptionally robust due to their simple design
- The comb joint principle provides user comfort and noise reduction

Vienne Viaduct, A7, France

Movement range

The capacity varies from 60 to 1,200 mm depending on the model.

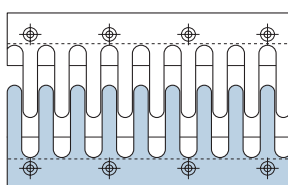

Fig.1

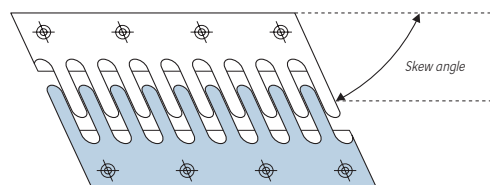

Fig.2

Water collection

A system for recovering runoff water may be combined with basic WP joints (type 1).

The system comprises either:

- A continuous elastomeric looped membrane over the entire length of the joint (type 2)
- An elastomeric section inserted between the metal elements (type 3)
- Two elastomeric or stainless steel sheet water recovery membranes with a gutter located under the joint (type 4)

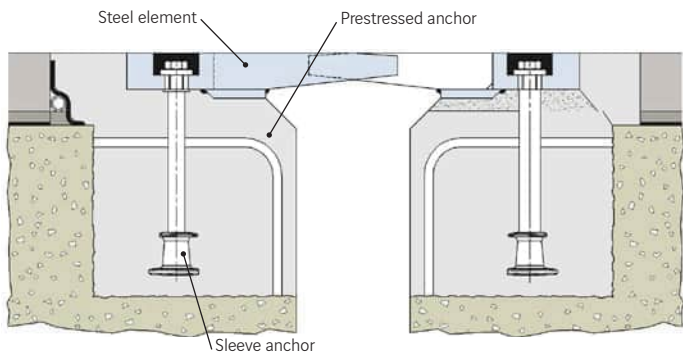

Type 1

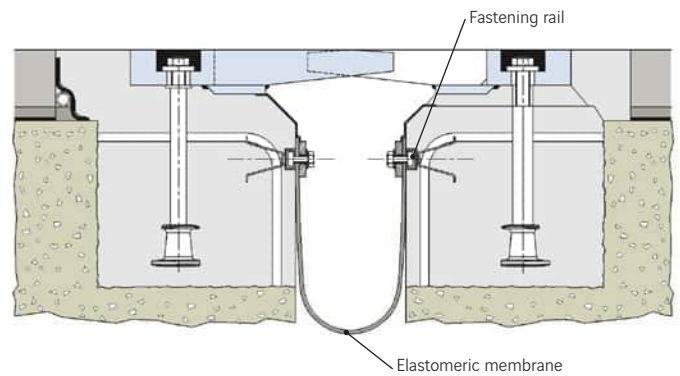

Type 2

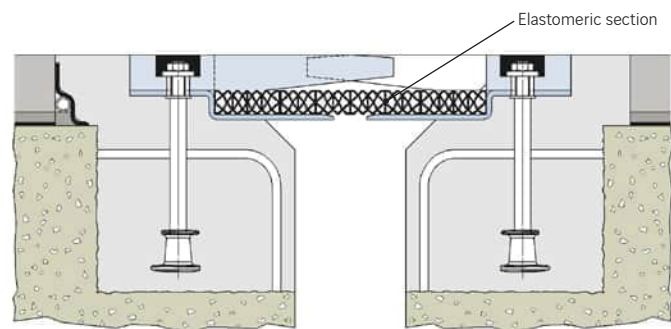

Type 3

Up to WP600

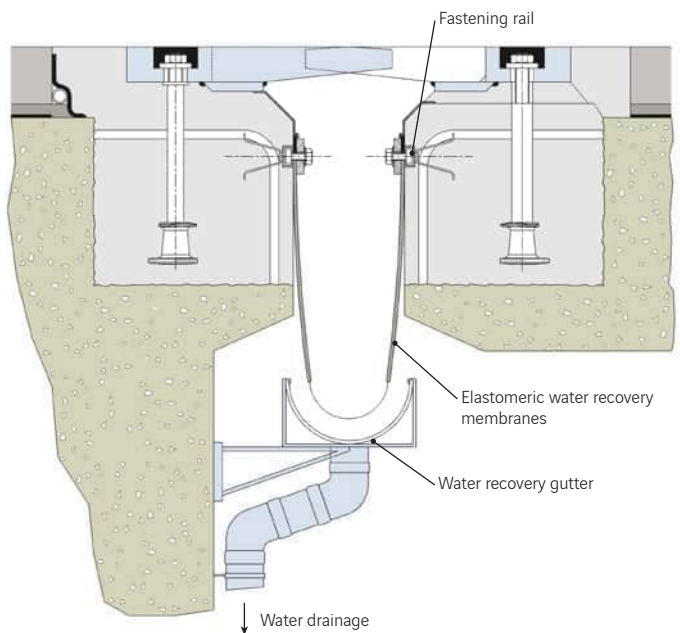

Type 4

CIPEC WP JOINT

Types 1, 2 and 4

Type 3

Type	B		G		E	H
	min.	max.	min.	max.	min.	min.
WP60	240	300	20	80	210	300
WP80	280	360	40	120	220	300
WP100	340	440	60	160	240	300
WP120	460	580	80	200	290	300
WP160	500	660	120	280	290	300
WP180	520	700	140	320	290	350
WP200	580	780	160	360	310	350
WP250	510	760	50	300	330	350
WP300	590	890	50	350	370	350
WP350	650	1,000	50	400	400	350
WP400	740	1,140	50	450	445	350
WP450	810	1,260	50	500	480	350
WP500	890	1,390	50	550	520	350
WP550	960	1,510	50	600	555	350
WP600	1020	1,620	50	650	585	350
WP700	1,160	1,860	50	750	655	350
WP800	1,480	2,280	50	850	815	350
WP900	1,610	2,510	50	950	880	350
WP1000	1,810	2,810	50	1,050	980	350
WP1100	1,910	3,010	50	1,150	1,030	350
WP1200	2,090	3,290	50	1,250	1,120	350

Not applicable to WP Type3 (see opposite)

Dimensions in mm

Aluminium type	B		G		E	H
	min.	max.	min.	max.	min.	min.
WP200	430	630	160	360	235	350
WP250	570	820	210	460	280	350
WP300	620	920	260	560	280	350

Dimensions in mm

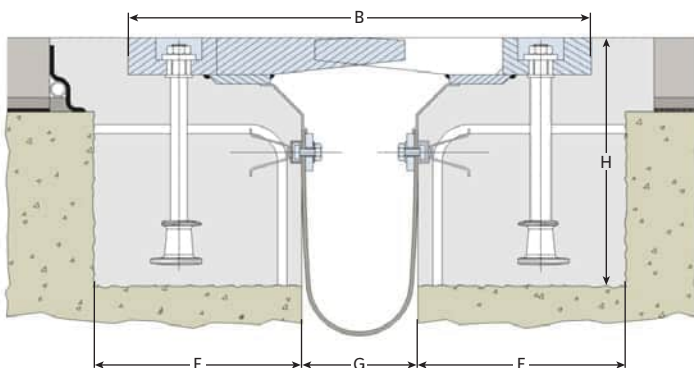

Type	B		G		E	H
	min.	max.	min.	max.	min.	min.
WP3 200	820	1,020	120	320	450	350
WP3 250	900	1,150	170	420	470	350
WP3 300	965	1,265	220	520	480	350
WP3 350	1,045	1,395	270	620	490	350
WP3 400	1,200	1,600	320	720	540	350
WP3 450	1,265	1,715	370	820	550	350
WP3 500	1,450	1,950	420	920	620	350
WP3 550	1,560	2,110	470	1,020	650	350
WP3 600	1,635	2,235	520	1,120	660	350

Dimensions in mm

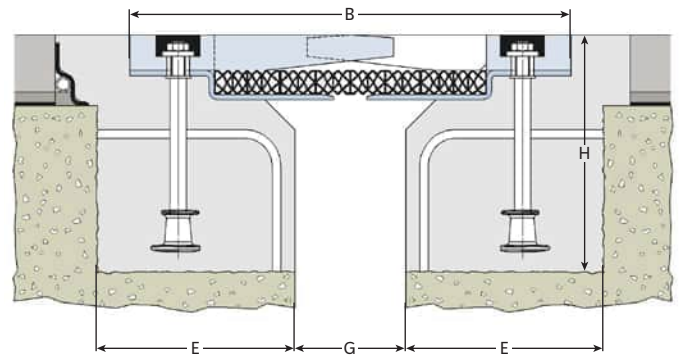

WP joint seen from below

Accessories

To ensure general expansion joint watertightness and joint continuity on footpaths (or non-traffic areas), the following accessories are available:

- Footpath joints (with or without water recovery membrane)
- End section upstands and kerb cover plates
- Drains (see page 33)

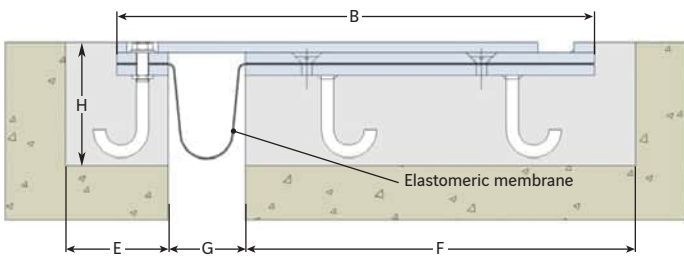

PL footpath joint

Type	Model	B		G		E	F	H
		min.	max.	min.	max.			
WP60	PL60	160	220	10	70	150	250	150
WP80	PL80	180	260	10	90	150	270	150
WP100	PL100	210	310	20	120	150	290	150
WP120	PL120	230	350	20	140	150	310	150
WP160	PL160	280	440	30	190	150	350	150
WP180	PL180	300	480	30	210	150	370	150
WP200	PL200	330	530	40	240	150	390	150
WP250	PL250	380	630	40	290	150	440	150
WP300	PL300	440	740	50	350	150	490	150
WP350	PL350	490	840	50	400	150	540	150
WP400	PL400	540	940	50	450	150	590	150
WP450	PL450	590	1,040	50	500	150	640	150
WP500	PL500	640	1,140	50	550	150	690	150
WP550	PL550	690	1,240	50	600	150	740	150
WP600	PL600	740	1,340	50	650	150	790	150
WP700	PL700	840	1,540	50	750	150	890	150
WP800	PL800	940	1,740	50	850	150	990	150
WP900	PL900	1,040	1,940	50	950	150	1,090	150
WP1000	PL1000	1,140	2,140	50	1,050	150	1,190	150
WP1100	PL1100	1,240	2,340	50	1,150	150	1,290	150
WP1200	PL1200	1,340	2,540	50	1,250	150	1,390	150

Dimensions in mm

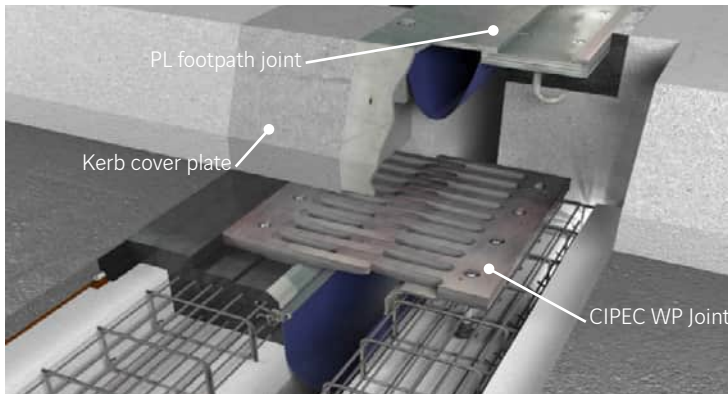

3D view of the footpath

Adaptation for cycle lanes

To provide maximum safety and comfort for cyclists, a specially designed metal sheet is added to joints on cycle lanes.



Adaptation for cycle lanes

NFT JOINT



Design

Belonging to the supported joint family, this joint comprises a robust metal plate securely anchored to the main structure and equipped with saw-teeth that bridge the gap and rest on a sliding surface. A rubber interface allows for rotation of the metal plate and absorbs impacts due to traffic. An innovative device prohibits any lifting of the metal components.



Specific features

- The exceptionally robust design makes the NFT joint very strong, including under intensive dynamic stress
- Excellent user comfort; the presence of saw-teeth reduces noise
- Upper surface has anti-skid grooves for optimum user safety
- Designed specifically for extreme exposure conditions and in particular to withstand snow clearing equipment
- NFT joints are manufactured to order and can be adapted to the directional movement of the main structure, straight (fig.1) or skew (fig.2)

Bridge over the Tecino river - Switzerland

Movement range

The capacity varies from 100 to 600 mm depending on the model.

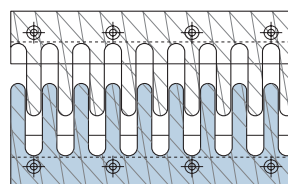

Fig.1

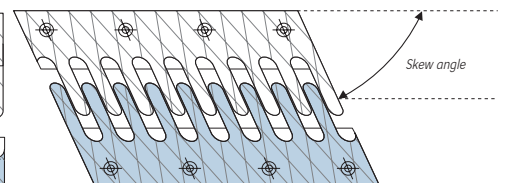
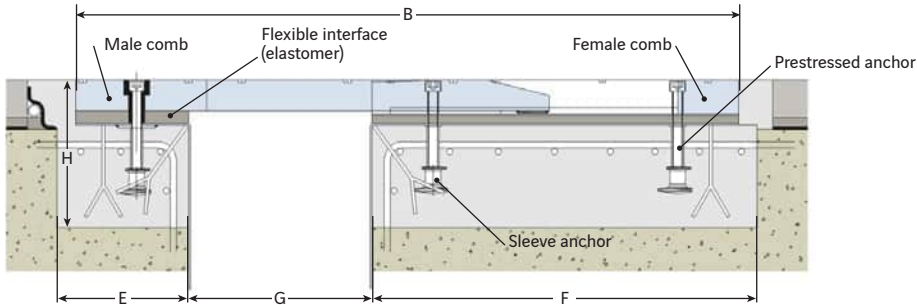

Fig.2

Technical data sheet



Type	B		G		E	F	H
	min.	max.	min.	max.	min.	min.	min.
NFT100	585	685	100	200	260	375	240
NFT200	685	885	100	300	260	475	240
NFT300	785	1,085	100	400	260	575	240
NFT400	885	1,285	100	500	260	675	240
NFT500	985	1,485	100	600	260	775	240
NFT600	1,085	1,685	100	700	260	875	240

Dimensions in mm

1. Installation of an NFT joint
2. NFT joint seam and footpath adaptation



Water collection

A system for recovering runoff water may be combined with NFT joints.

The system comprises either:

- Two elastomeric or stainless steel sheet water recovery membranes with a gutter located under the joint ▶
- A continuous elastomeric looped membrane over the entire length of the joint ▼

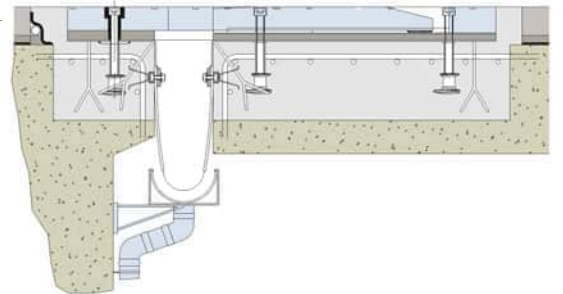
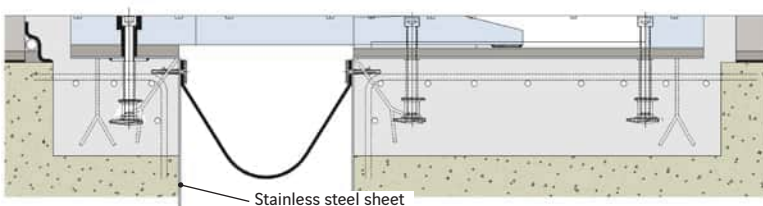

Accessories

To ensure general expansion joint watertightness and joint continuity on footpaths (or non-traffic areas), the following accessories are available:

- Footpath joints (with or without water recovery membrane)
- End section upstands and kerb cover plates
- Drains (see page 33)

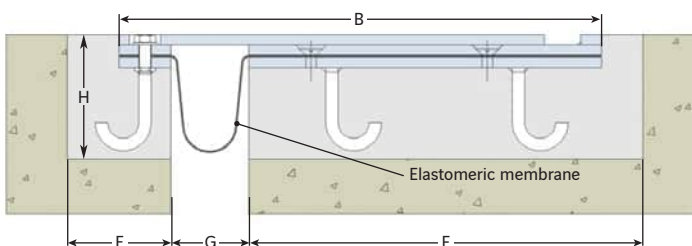

PL footpath joint

Type	Model	B		G		E	F	H
		min.	max.	min.	max.	min.	min.	min.
NFT100	PL100	210	310	20	120	150	290	150
NFT200	PL200	330	530	40	240	150	390	150
NFT300	PL300	440	740	50	350	150	490	150
NFT400	PL400	540	940	50	450	150	590	150
NFT500	PL500	640	1,140	50	550	150	690	150
NFT600	PL600	740	1,340	50	650	150	790	150

Dimensions in mm

MULTIFLEX SX JOINT



Design

The Multiflex SX joint is a mat joint in which movement imposed by the main structure is absorbed by deformation of the elastomeric sections. It comprises vulcanised moulded elastomeric elements 1 or 2 metres in length (depending on the model) bonded to metal inserts designed to accommodate moving loads and distribute stress in the fasteners.

Specific features

- Complete watertightness ensured by total continuity of the elastomer on the elements and the positioning of a high quality adhesive seal where the elements meet
- The elastomer contact enables absorption of wheel impact and road surface irregularities, thereby providing an excellent level of user comfort
- Upper surface has anti-skid grooves for optimum user safety
- Very effectively accommodates transverse, vertical and rotational movements of the main structure
- Steel inserts entirely elastomer coated, fully protected against corrosion and chemical attack (oil, grease, hydrocarbons and de-icing salts)
- Simple installation, can be installed directly without recesses in the main structure

Saadiyat Bridge - United Arab Emirates

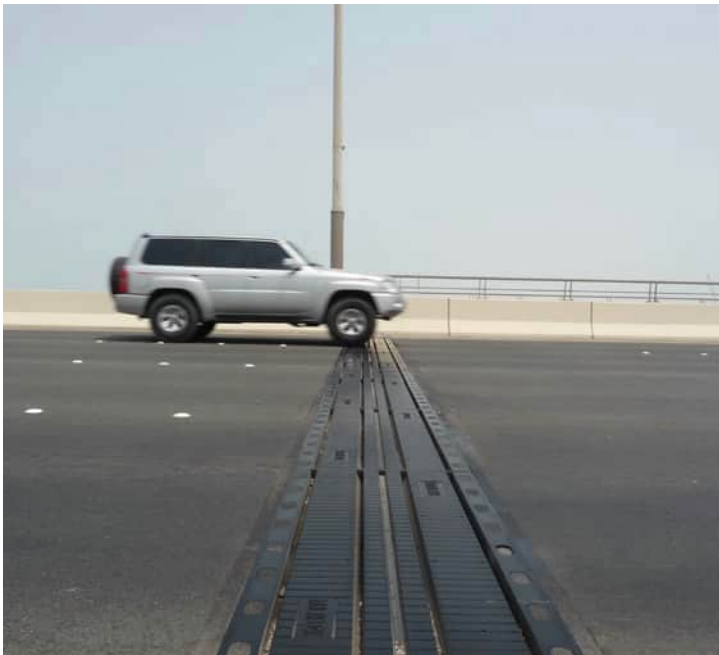

Movement range

Movement capacity by model depending on skew angle (α) of the main structure.

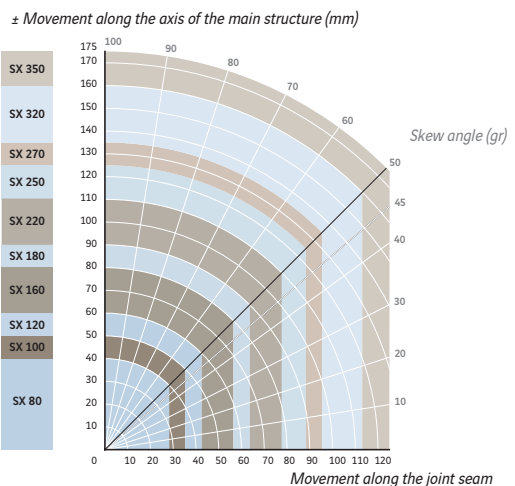
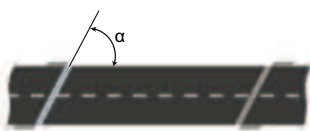

Technical data sheet

There are two different designs, the single module joint and the bridged joint. They have different movement capacities.

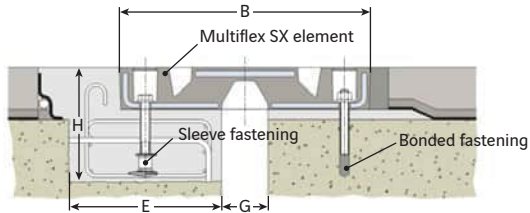

Single element module

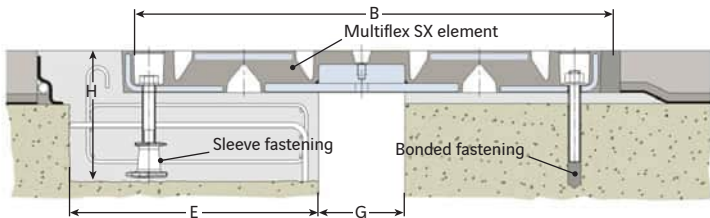

Double element module

Type	Module	B		G		E	H
		min.	max.	min.	max.		
SX80	single	235	315	10	90	195	190
SX100	single	305	405	10	110	225	190
SX120	single	330	450	10	130	235	210
SX160	single	390	550	10	170	265	230
SX180	single	410	590	10	190	275	230

Dimensions in mm

Type	Module	B		G		E	H
		min.	max.	min.	max.		
SX220	double	690	910	10	230	415	250
SX250	double	915	1,165	10	260	535	250
SX270	double	755	1,025	15	285	445	260
SX320	double	1,115	1,435	60	380	605	350
SX350	double	930	1,280	45	395	525	360

Dimensions in mm

Accessories

To ensure general expansion joint watertightness and joint continuity on footpaths (or non-traffic areas), the following accessories are available:

- Footpath joints
- End section upstands and kerb cover plates
- Drains (see page 33)



1. Tailor-made footpath upstand
2. PL footpath joint adaptation

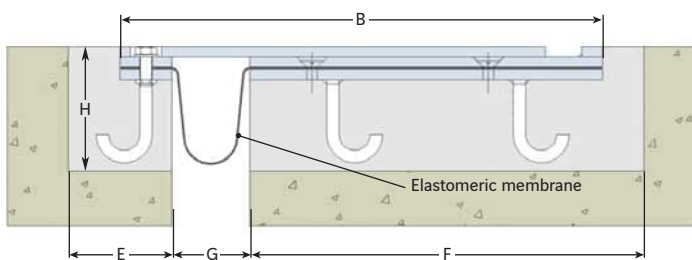
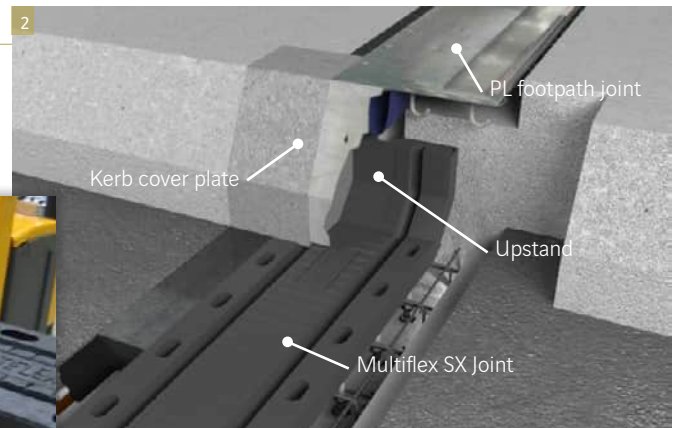

PL footpath joint

Type	Model	B		G		E	F	H
		min.	max.	min.	max.			
SX80	PL80	180	260	10	90	150	270	150
SX100	PL100	210	310	20	120	150	290	150
SX120	PL120	230	350	20	140	150	310	150
SX160	PL160	280	440	30	190	150	350	150
SX180	PL180	300	480	30	210	150	370	150
SX220	PL230	360	590	40	270	150	420	150
SX250	PL250	380	630	40	290	150	440	150
SX270	PL300	440	740	50	350	150	490	150
SX320	PL350	490	840	50	400	150	540	150
SX350	PL350	490	840	50	400	150	540	150

Dimensions in mm

FREYSSIMOD LW JOINT



Design

Belonging to the modular joint family, this joint comprises special steel sections with elastomer sections installed between them. The movement capacity is determined by the number of sections chosen. There are 3 models:

- LW 80: no intermediate sections therefore no support bar (small movements)
- LW model T: with multiple support bars (medium movements)
- LW model L: with monolithic support bars (large movements)

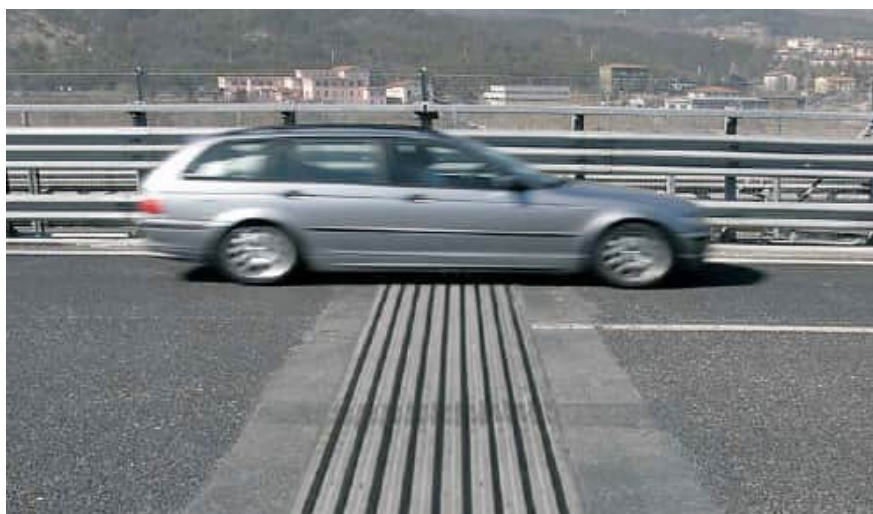

Specific features

- Totally watertight, requires no water collection system
- Installation in a single piece
- Suitable for curved bridges or movements not parallel to the roadway
- Accepts vertical movements, rotational movements and deformations of the main structure
- Durable and low-maintenance

Freyssimod LW joint seam

Movement range

Freyssimod LW joints are manufactured to order and can be adapted to the directional movement of the main structure, straight or skew. The capacity varies from 80 to 960 mm depending on the model, but larger movement capacities can be provided on request.

Installation



Technical data sheet

Type	Range	Movement	B		G		E	F	H	K
			min.	max.	min.	max.	min.	min.	min.	min.
LW80	1	±40	80	160	30	110	350	350	250	-
LW160	2	±80	160	320	110	270	350	350	300	210
LW240	3	±120	240	480	190	430	590	350	370	350
LW320	4	±160	320	640	270	590	670	350	380	480
LW400	5	±200	400	800	350	750	750	350	390	340
LW480	6	±240	480	960	430	910	800	350	400	340
LW560	7	±280	560	1,120	510	1,070	880	350	420	340
LW640	8	±320	640	1,280	590	1,230	960	350	430	370
LW720	9	±360	720	1,440	670	1,390	1,040	350	450	370
LW800	10	±400	800	1,600	750	1,550	1,140	350	460	370
LW880	11	±440	880	1,760	830	1,710	1,200	350	470	390
LW960	12	±480	960	1,920	910	1,870	1,280	350	480	390

Freyssimod LW 80

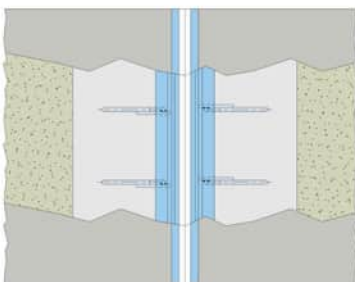
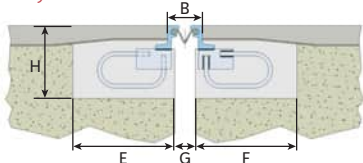

Freyssimod LW - Mod. T

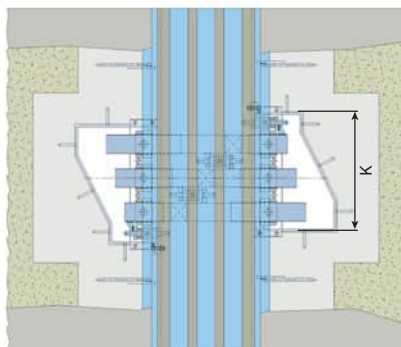
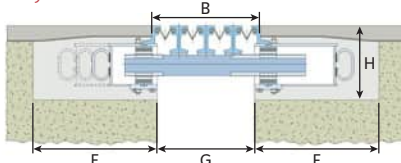

Freyssimod LW - Mod. L

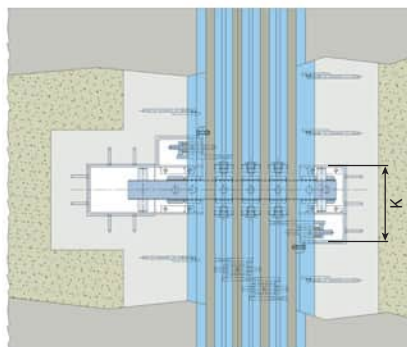
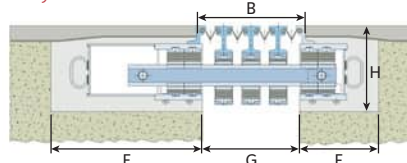

Footpath joint

There are two options for creating the footpath joint:

- The joint sections exactly match the footpath geometry
- A simple slanted upstand combined with a PL joint, covered with steel sheet

3D views of the footpath

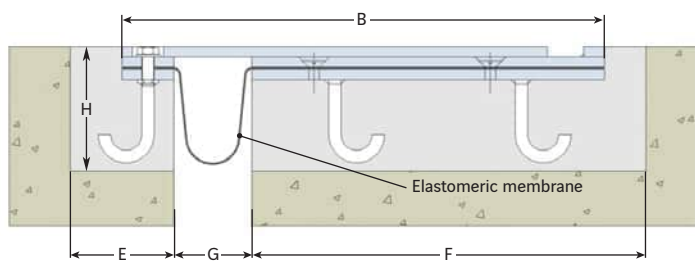
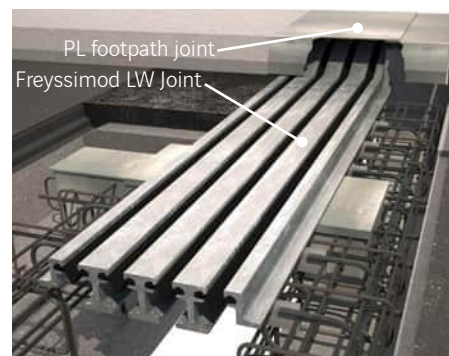
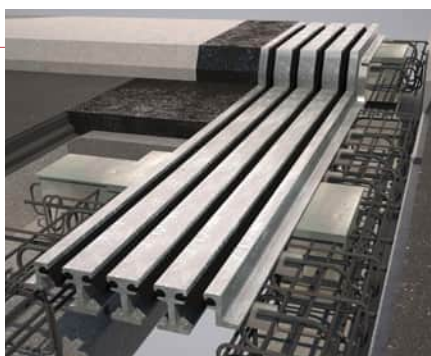

PL footpath joint

Type	Model	B		G		E	F	H
		min.	max.	min.	max.	min.	min.	min.
LW80	PL80	180	260	10	90	150	270	150
LW160	PL160	280	440	30	190	150	350	150
LW240	PL250	380	630	40	290	150	440	150
LW320	PL350	490	840	50	400	150	540	150
LW400	PL400	540	940	50	450	150	590	150
LW480	PL500	640	1,140	50	550	150	690	150
LW560	PL600	740	1,340	50	650	150	790	150
LW640	PL700	840	1,540	50	750	150	890	150
LW720	PL800	940	1,740	50	850	150	990	150
LW800	PL800	940	1,740	50	850	150	990	150
LW880	PL900	1,040	1,940	50	950	150	1,090	150
LW960	PL1000	1,140	2,140	50	1,050	150	1,190	150

VIAJOINT

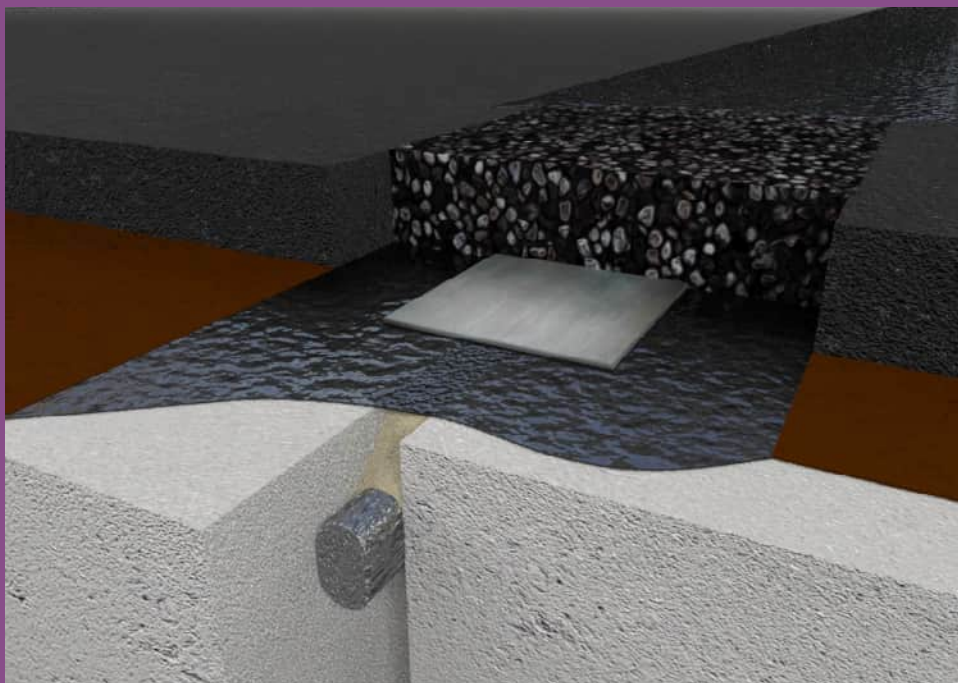

Design

Viajoint is the product of highly sophisticated design processes: the choice of constituent materials and ultra-precise quantity proportioning ensure optimum quality.

It consists of a bitumen-elastomer binder ensuring complete bonding to the substrate, watertightness and bridging elasticity. The addition of rigorously selected granular aggregate provides excellent mechanical strength. An aluminium section provides mechanical bridging.



Specific features

- Suitable for any type of road surface and requires no maintenance irrespective of traffic conditions
- Provides excellent user comfort and noise control
- Cost-effective solution
- Traffic flow can be resumed very quickly

Movement capacity

The maximum movement capacity of this joint is 20 mm. This type of joint accepts skew angles up to 50 gr.



Slanted Viajoint seam

Viajoint seam

Installation

Viajoint is installed after cutting and stripping the existing road surface material. Once the joint base is installed the recess is filled with the preheated aggregate and the bitumen-elastomer binder in 40 to 60 mm layers. Each step requires expertise and special precautions and calls for qualified and experienced personnel.

1. Pouring the first layer of binder
2. Introducing the aggregate
3. Installation equipment



Technical data sheet

As the joint is not adjustable, the movement value (20 mm) can only be attained if installation is carried out at a temperature corresponding to the average of the extreme temperatures for the region.

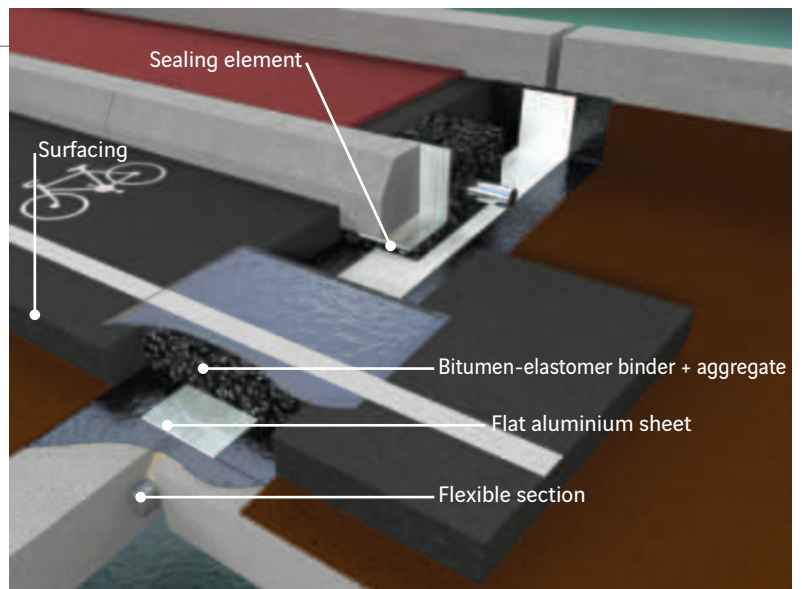
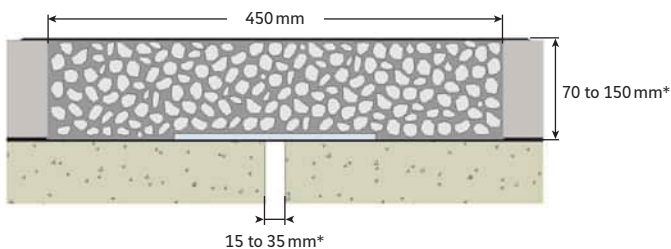

* For values under 70 mm, please contact us

** For other values, please contact us

TRANSPEC 4-18

Simulation of a collision on a crash barrier with or without the Transpec 4-18

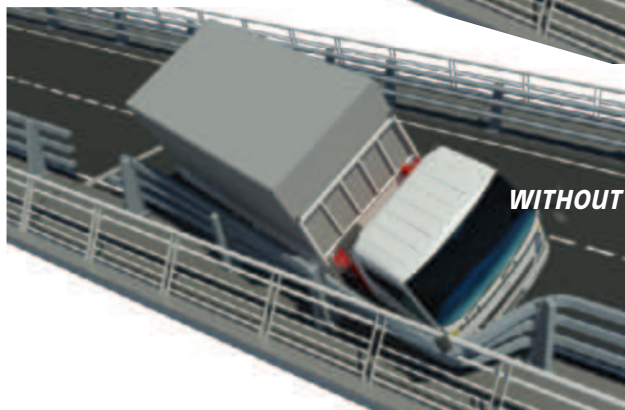
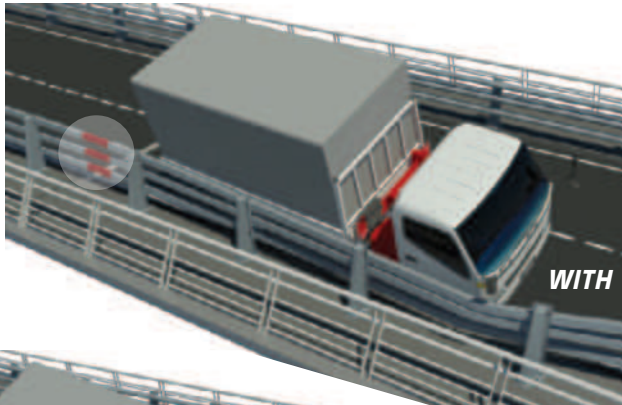

Principle

Designed by Freyssinet and unique in the world, the Transpec 4-18 ensures mechanical continuity of safety barriers at roadway expansion joints, while also accommodating longitudinal deck movements. In normal operation the Transpec 4-18 slides freely. In the event of a vehicle collision in the vicinity of an expansion joint, the Transpec 4-18 takes up the load and inhibits deformation by locking the previously separated barrier elements together. The vehicle is therefore prevented from going through the barrier.

Specific features

- Process tested and proven fully effective under actual conditions. The Transpec 4-18 is positioned inside BN4 barrier rails and requires no specific or special arrangement
- It can also be fitted to other models of protection barrier subject to a special design study
- Installation of Transpec 4-18 is strongly recommended for movements from 150 mm



Barrier fitted with two Transpec 4-18s

Detail of connection to barrier



Application on a guardrail

COMPLEMENTARY DEVICES

Drain

A drain should be installed before the joint to collect and remove any water runoff that may infiltrate into the deck surface layers. This prevents a build up of water in this area that could damage the flashing. The drain is comprised of a continuous stainless steel coil along the length of the joint protected by a bituminous strip.

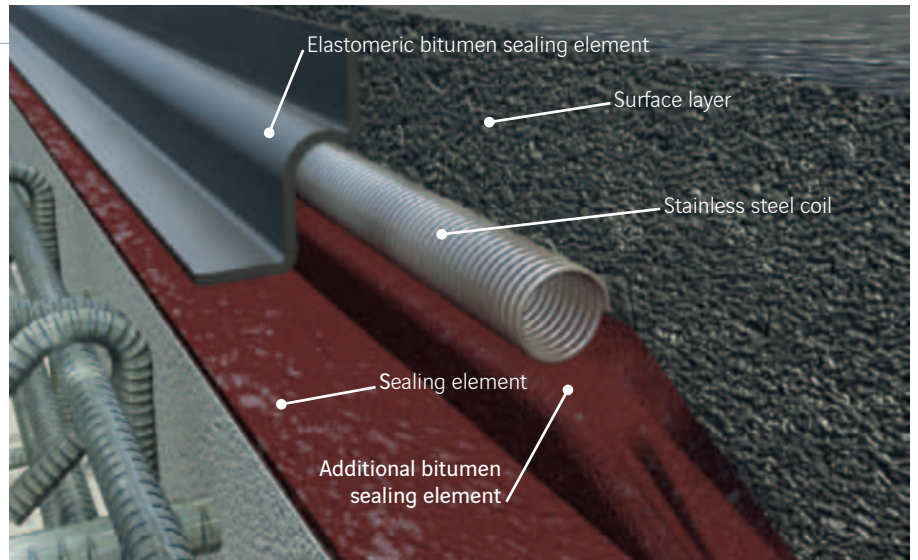
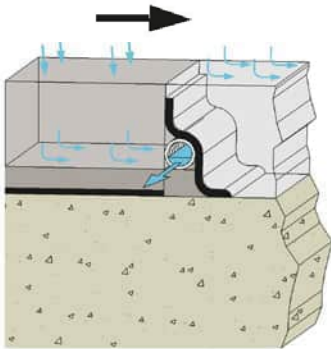

Detail of drain assembly

Gully

Principle

Device intended to remove water from a deck with efficient connection to the general waterproofing and evacuation system.

Assembly compliant with French ST.E.R 81 requirements sub-dossier E Section II, published by SETRA.

Description

The all cast steel components of this CIPEC gully are as follows:

- Base tube with flange (1 unit)
- Riser (number depending on height of surface layer)
- Inlet - grating support with two bolts (1 unit)
- Grating (1 unit)
- Grating bolts (1 pair)

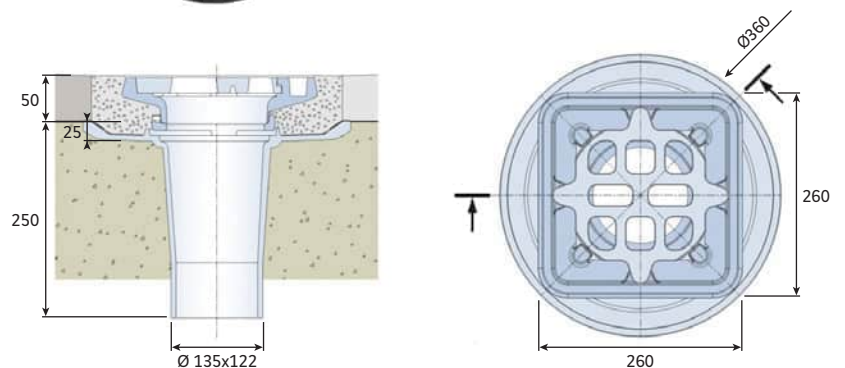
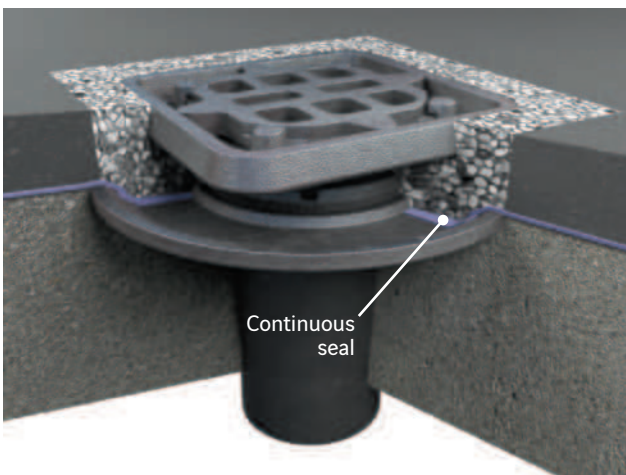

Basic assembly with one riser

MANUFACTURING OF JOINTS

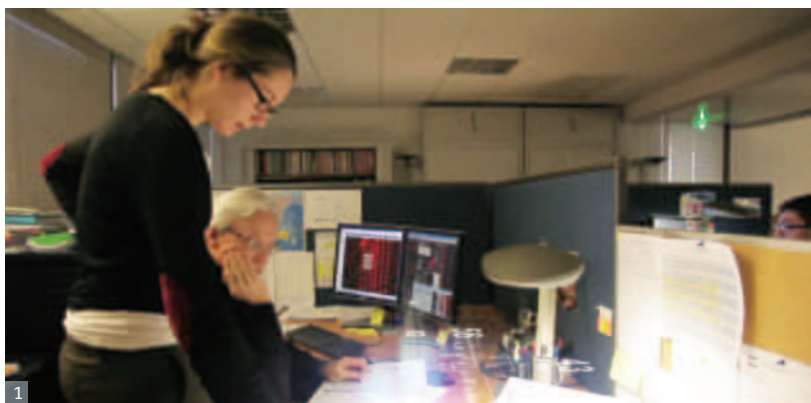

Because we manufacture our expansion joints ourselves, we guarantee all of our customers the same level of excellence and quality in our products and services. This complete control over our products and systems means that we can adapt our solutions to a wide range of applications and extreme operating conditions.

Products designed and manufactured by Freyssinet

All Freyssinet expansion joints are conceived and designed by an in-house technical department that adapts them to comply with the relevant standards and project specifications. Coordination between the design, manufacturing solutions and choice of materials is essential to optimise our solutions and provide reliable, durable products.

Our in-house mechanical testing centre with its specialist equipment carries out full-scale testing on most of our products during both the product development and approval phases.

Certified products

Recognition of Freyssinet's expertise and high-quality processes is reflected in a number of certifications in a wide range of fields. Our expansion joints have gained recognition around the world from such bodies as: SETRA (France) • TZUS (Czech Republic) • AREVA (Nuclear) • TNSISS (Russia) • ASME (Nuclear) • EDF (Nuclear, Hydraulics) • SNCF (France) • DNV SUBSEA 7 (Off Shore) • INTRATEC (Nuclear, China) • IBDIM (Poland) • Politecnico Di Milano (CE Marking) • AFAQ-AFNOR (ISO Certification), and many others.

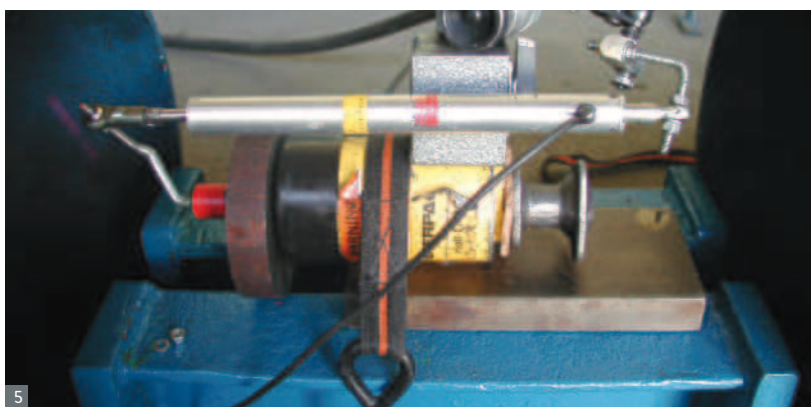

Expertise and industrial know-how

Based in France, our industrial division FPC (Freysinet Products Company) acts as a focal point for all of Freyssinet's expertise in materials, manufacturing, production engineering, control and logistics. It coordinates all of our production activities worldwide. A large contingent of experts in smelting, elastomers, mechanical engineering and quality travels the length and breadth of the five continents to define and monitor the manufacturing processes and guarantee the same level of product quality, irrespective of the production location.

Guaranteed quality

The vast network of FPC-managed production sites requires daily involvement from the quality control department, which guarantees the quality and conformity of the products supplied. All products are checked by FPC, using its cutting-edge measuring instruments.

All check points are defined internally, and FPC issues a certificate of conformity for each product supplied.

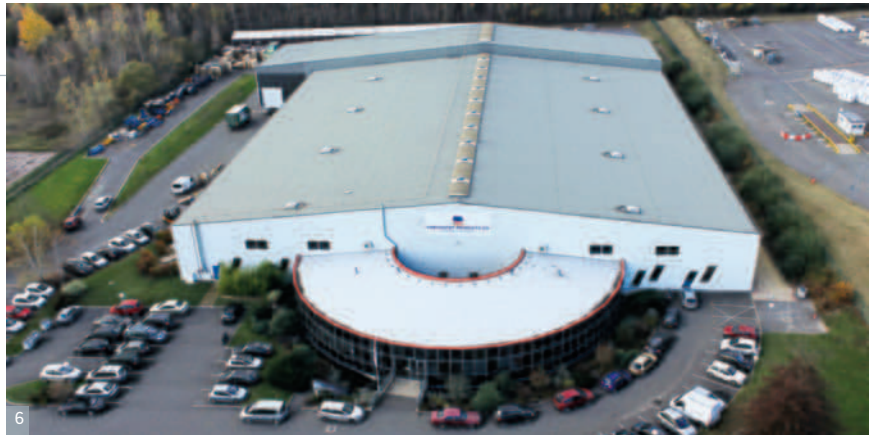

1. Design office
2. Freyssimod LW joint assembly
3. Fatigue testing a WP joint
4. Watertightness testing a WD joint
5. Testing a sleeve anchor
6. The FPC building (external view)
7. The FPC building (internal view)
8. Capacity testing a WM joint
9. Dimensional check on a WP joint.
10. Dimensional check on a WM joint



Over 60 locations worldwide

AMERICAS . Argentina . Brazil . Canada . Chile . Colombia . United States . Mexico . Panama . El Salvador . Venezuela .
EUROPE . Belgium . Bulgaria . Denmark . Spain . Estonia . France . Hungary . Ireland . Iceland . Latvia . Lithuania . Luxembourg . Macedonia . Norway .
Netherlands . Poland . Portugal . Czech Republic . Romania . United Kingdom . Russia . Serbia . Slovenia . Sweden . Switzerland . Turkey .
AFRICA AND MIDDLE EAST . Abu Dhabi . South Africa . Algeria . Saudi Arabia . Dubai . Egypt . Jordan . Kuwait . Morocco . Oman .
Qatar . Sharjah . Tunisia . ASIA . South Korea . Hong Kong . India . Indonesia . Japan . Macau . Malaysia . Pakistan . Philippines . Singapore .
Thailand . Taiwan . Vietnam . OCEANIA . Australia . New Zealand



FREYSSINET
SUSTAINABLE TECHNOLOGY



www.freyssinet.com

Follow us on:

